



(19) **United States**

(12) **Patent Application Publication**
Matsui et al.

(10) **Pub. No.: US 2012/0200611 A1**

(43) **Pub. Date: Aug. 9, 2012**

(54) **DISPLAY DEVICE AND METHOD OF CONTROLLING THE SAME**

Publication Classification

(75) Inventors: **Masafumi Matsui**, Kyoto (JP);
Shinya Ono, Osaka (JP)

(51) **Int. Cl.**
G09G 3/30 (2006.01)
G09G 5/10 (2006.01)

(52) **U.S. Cl.** **345/690; 345/77**

(73) Assignee: **Panasonic Corporation**, Osaka (JP)

(57) **ABSTRACT**

(21) Appl. No.: **13/443,375**

(22) Filed: **Apr. 10, 2012**

A display device including pixels has formed therein at least two driving blocks each made up of pixel rows, and includes: a signal line driving circuit that outputs a signal voltage to an output line disposed in each of pixel columns; and a selector circuit that controls a selector disposed in each of the columns for providing a signal voltage outputted from the output line to one of a first signal line and second signal line disposed in each of the columns, and selectively provides a standard voltage or the signal voltage outputted from the output line to one of the first signal line or the second signal line. Each of the pixels includes a current control unit and an organic EL element. Pixels in the k-th driving block are connected to the first signal line and pixels in the (k+1)-th driving block are connected to the second signal line.

Related U.S. Application Data

(63) Continuation of application No. PCT/JP2010/005471, filed on Sep. 6, 2010.

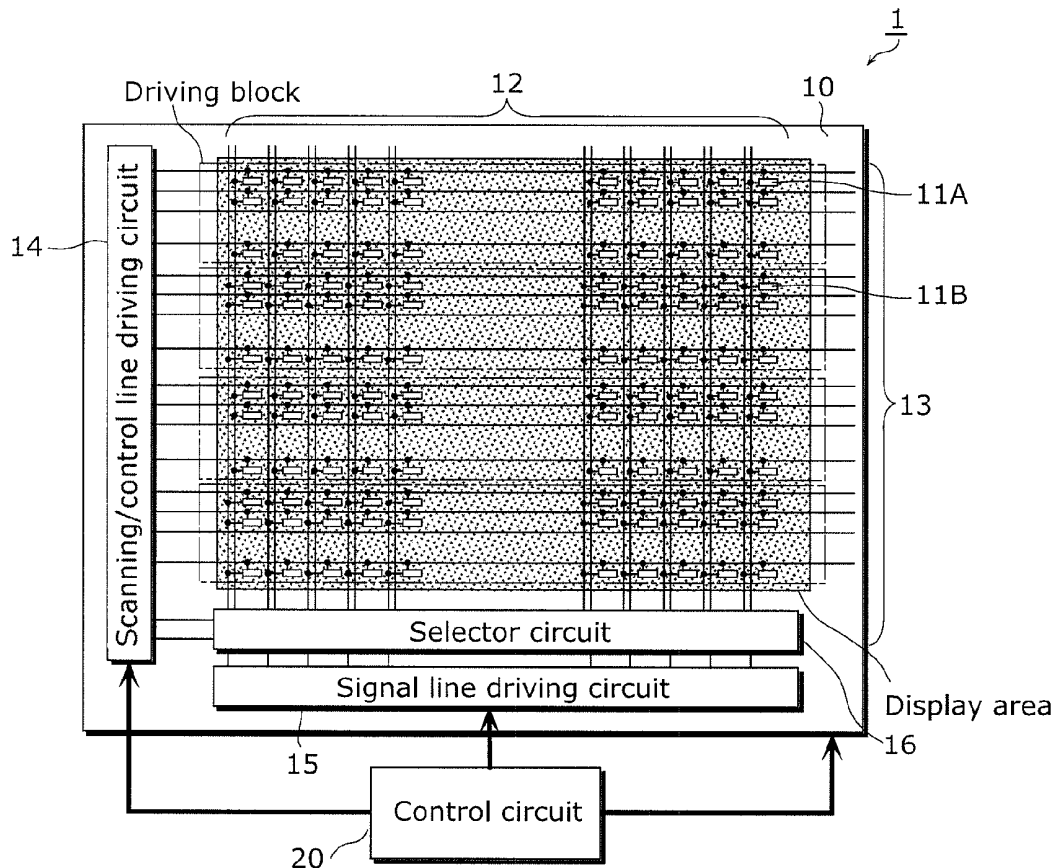

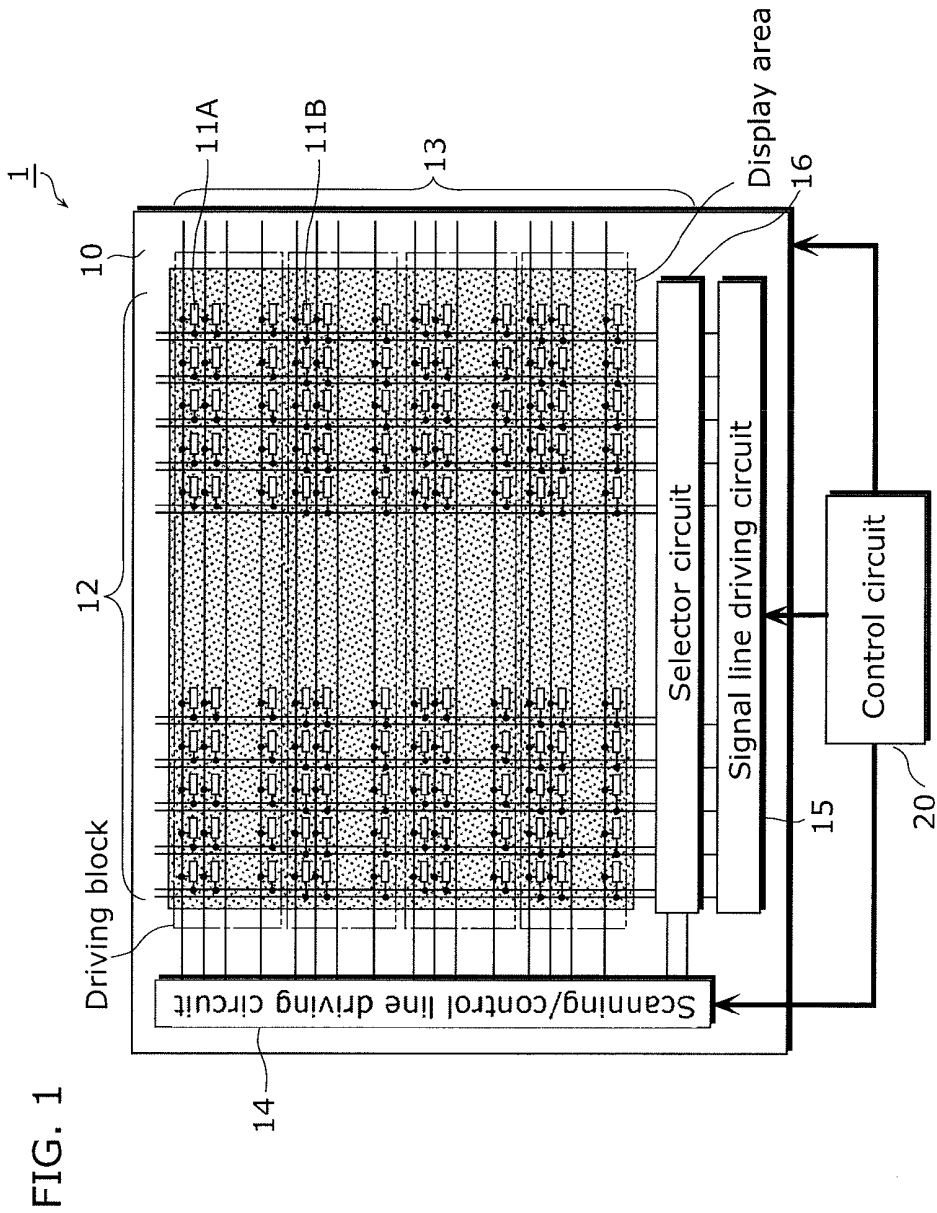

FIG. 3

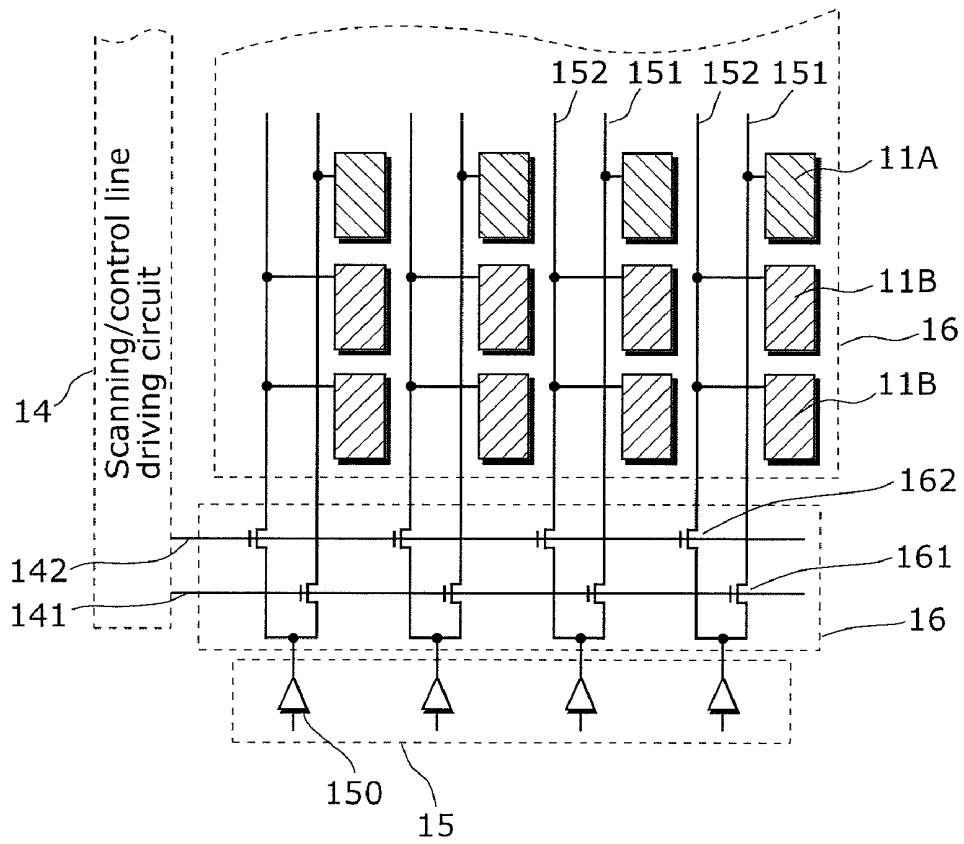

FIG. 4

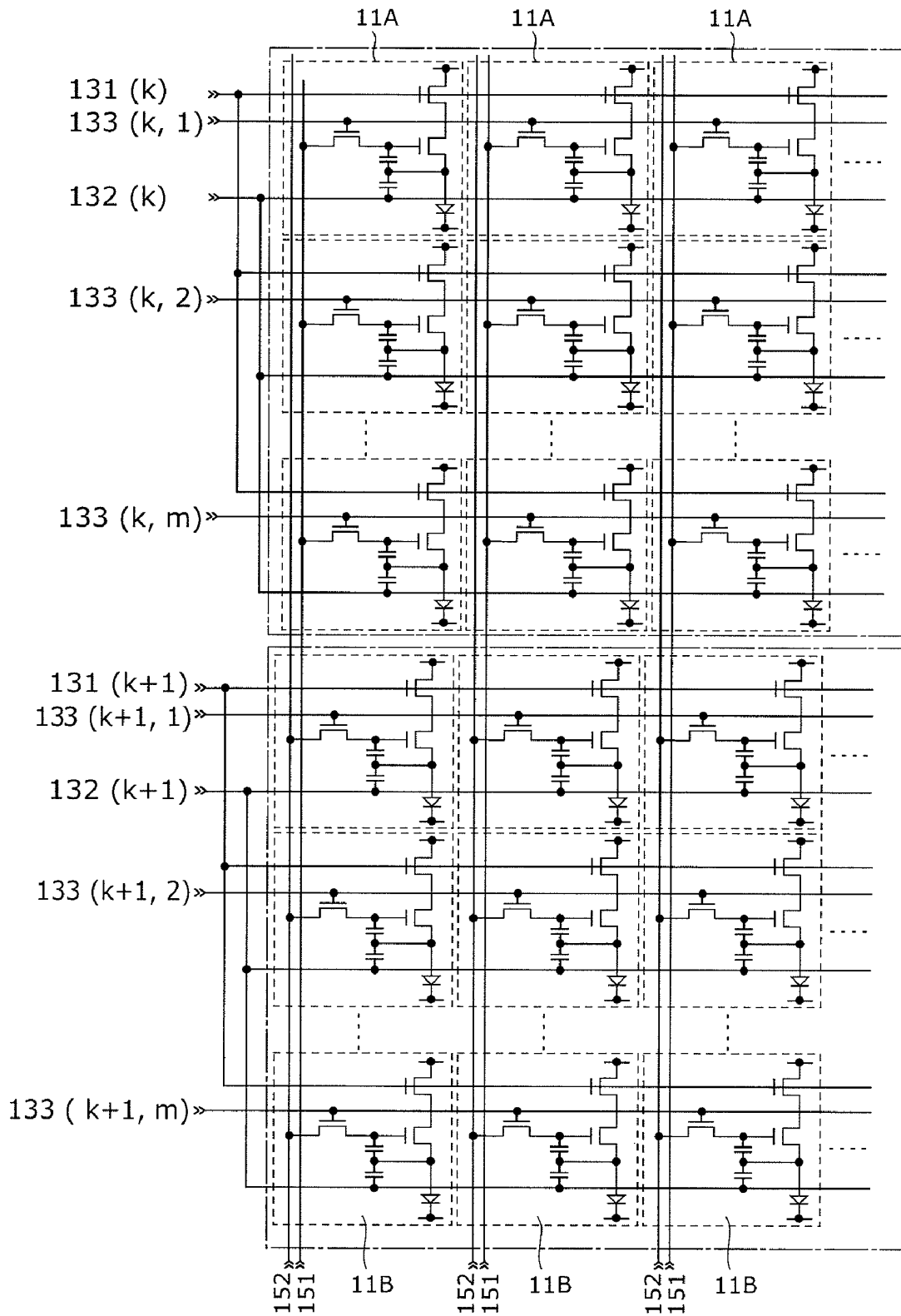

FIG. 5

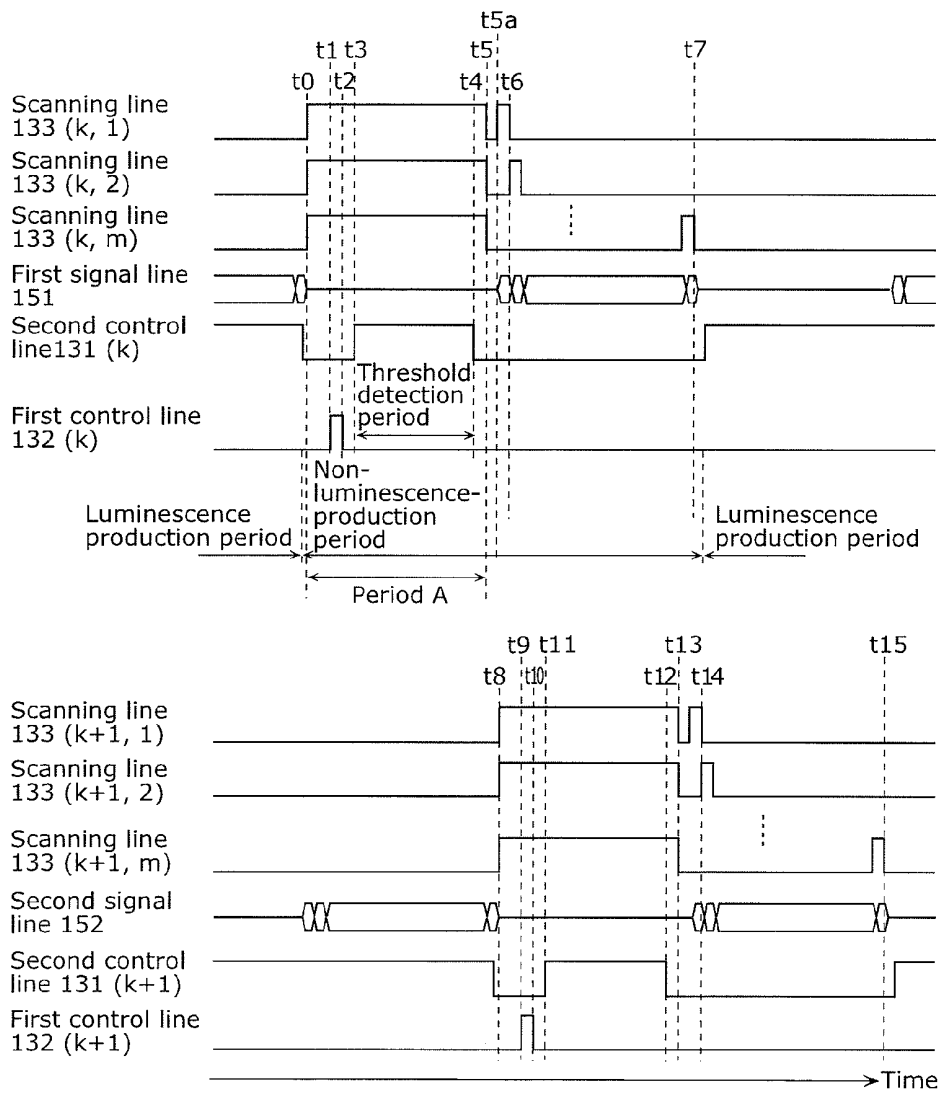
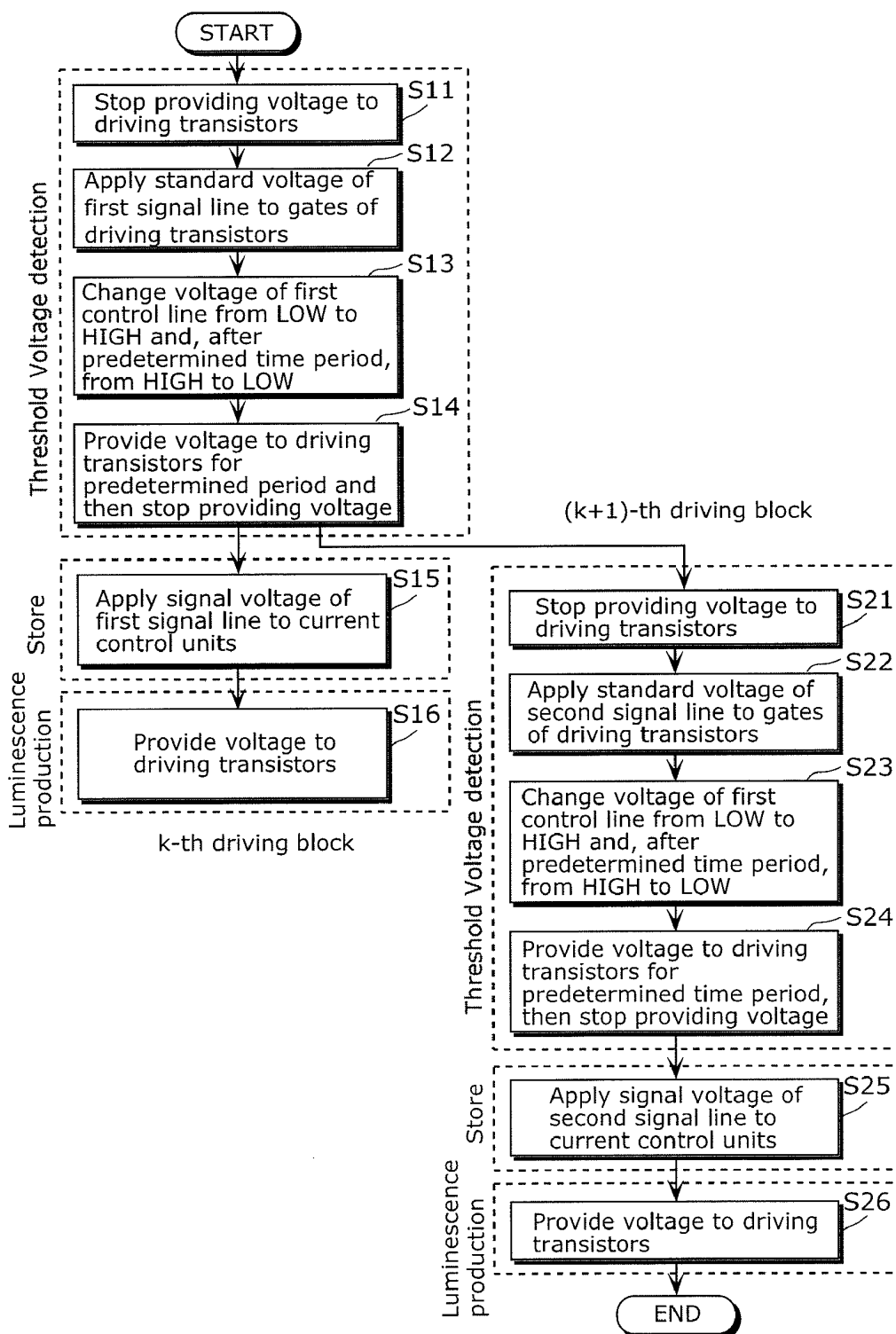

FIG. 7



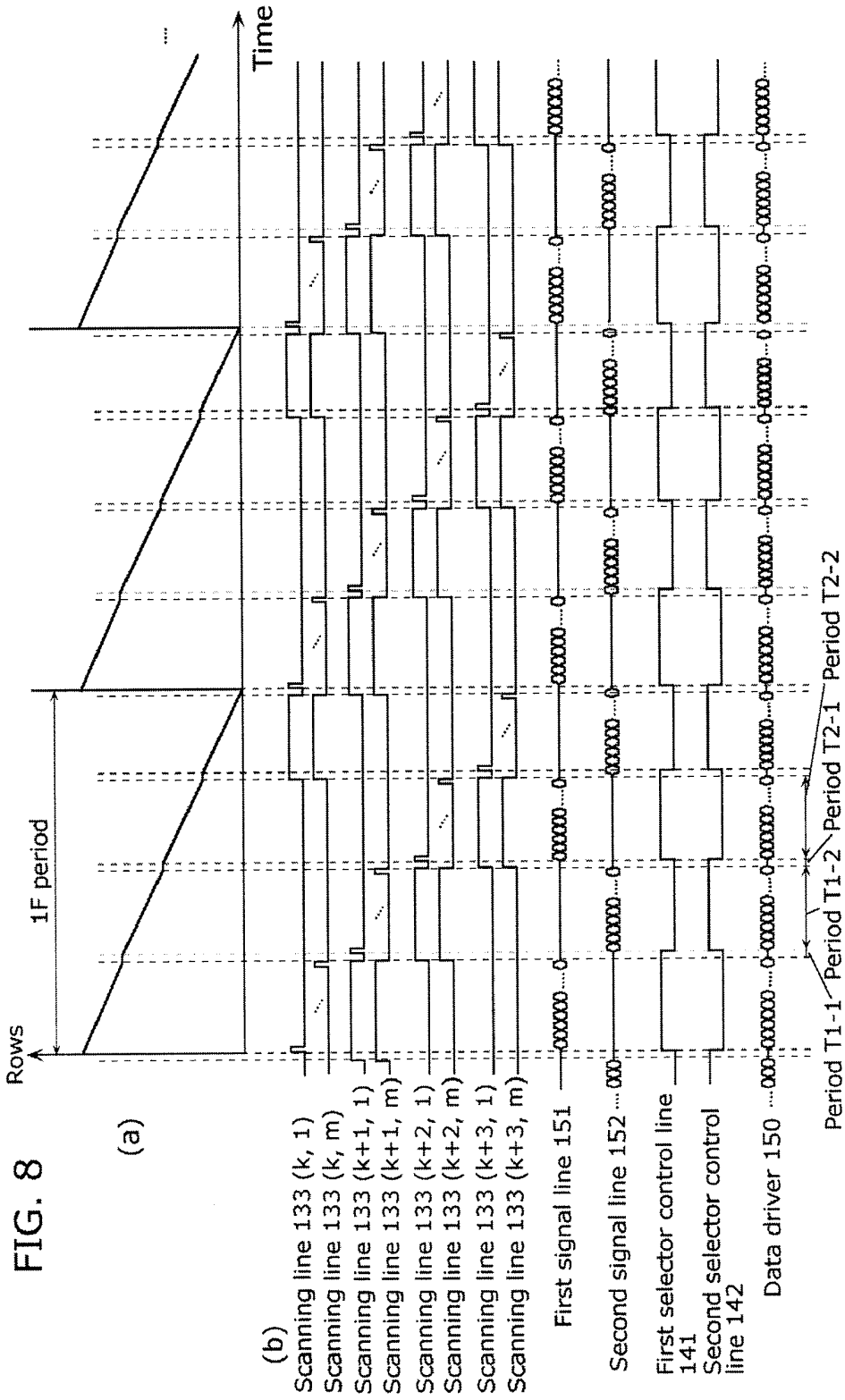

FIG. 9A

(Period T1-1)

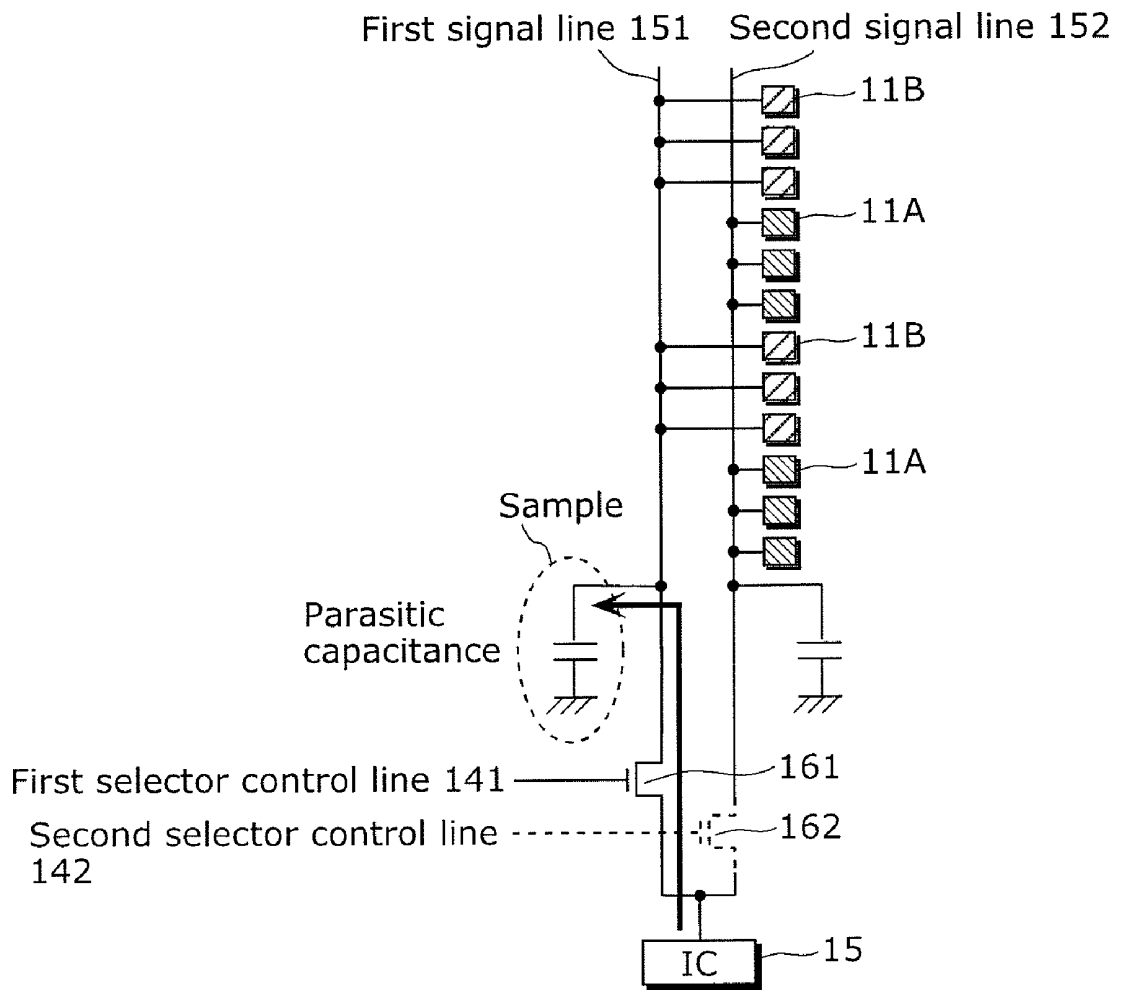

FIG. 9B

(Period T1-2)

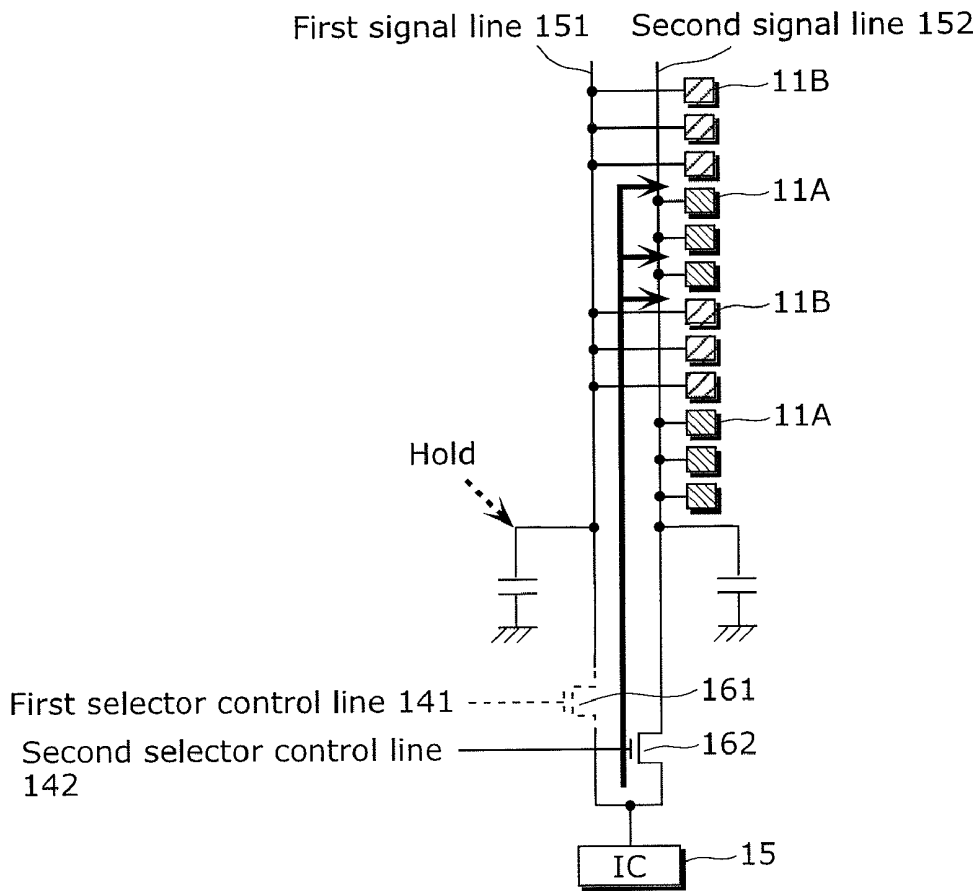

FIG. 9C

(Period T2-1)

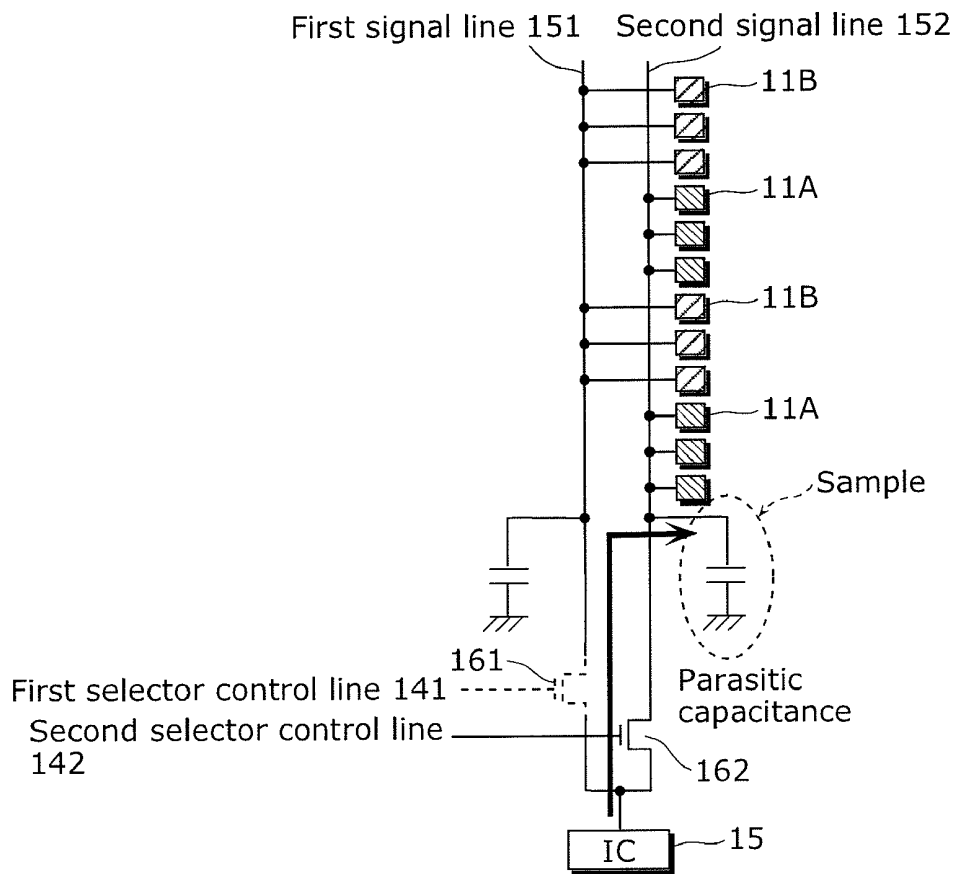

FIG. 9D

(Period T2-2)

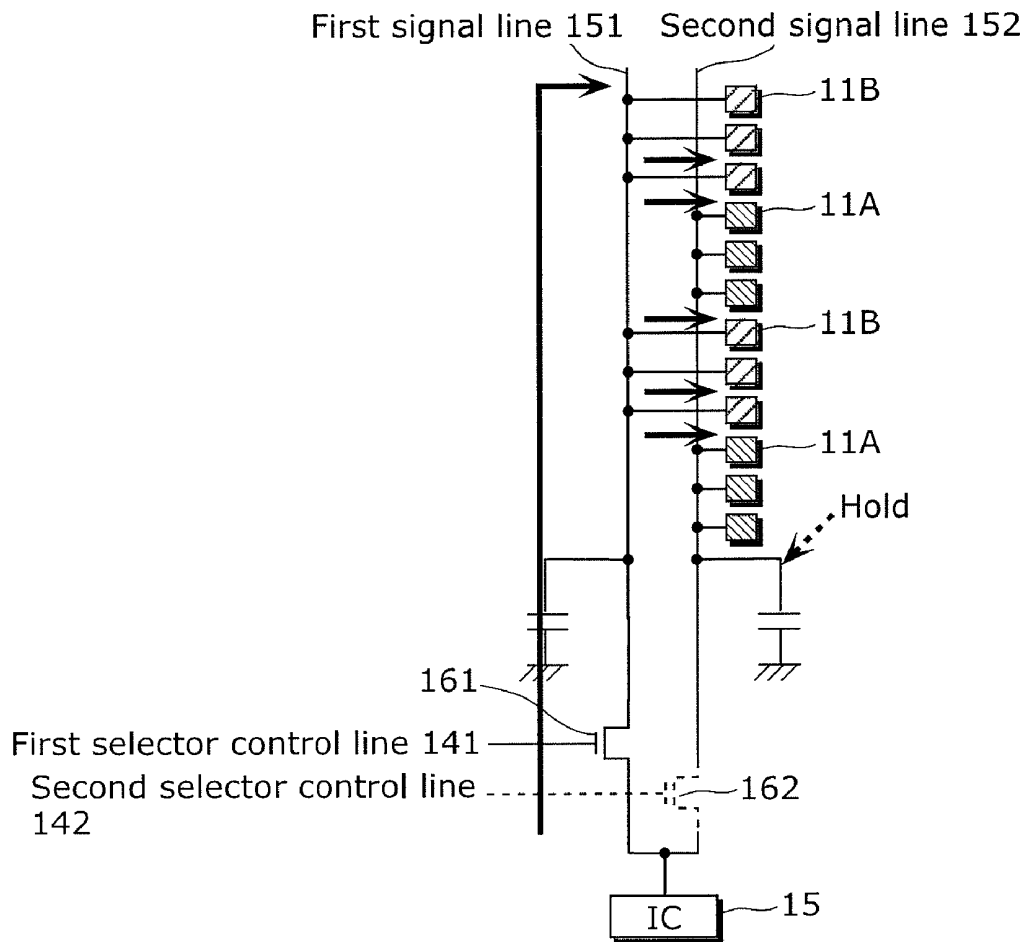

FIG. 10

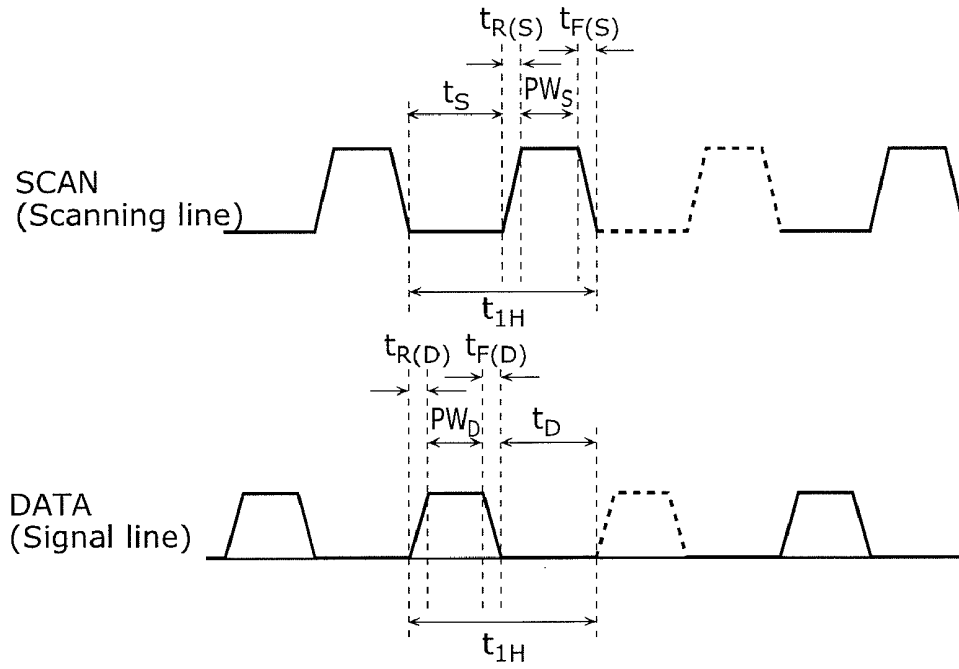

FIG. 11

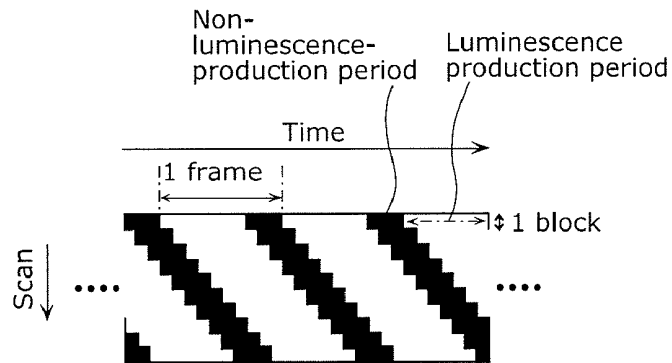

FIG. 12

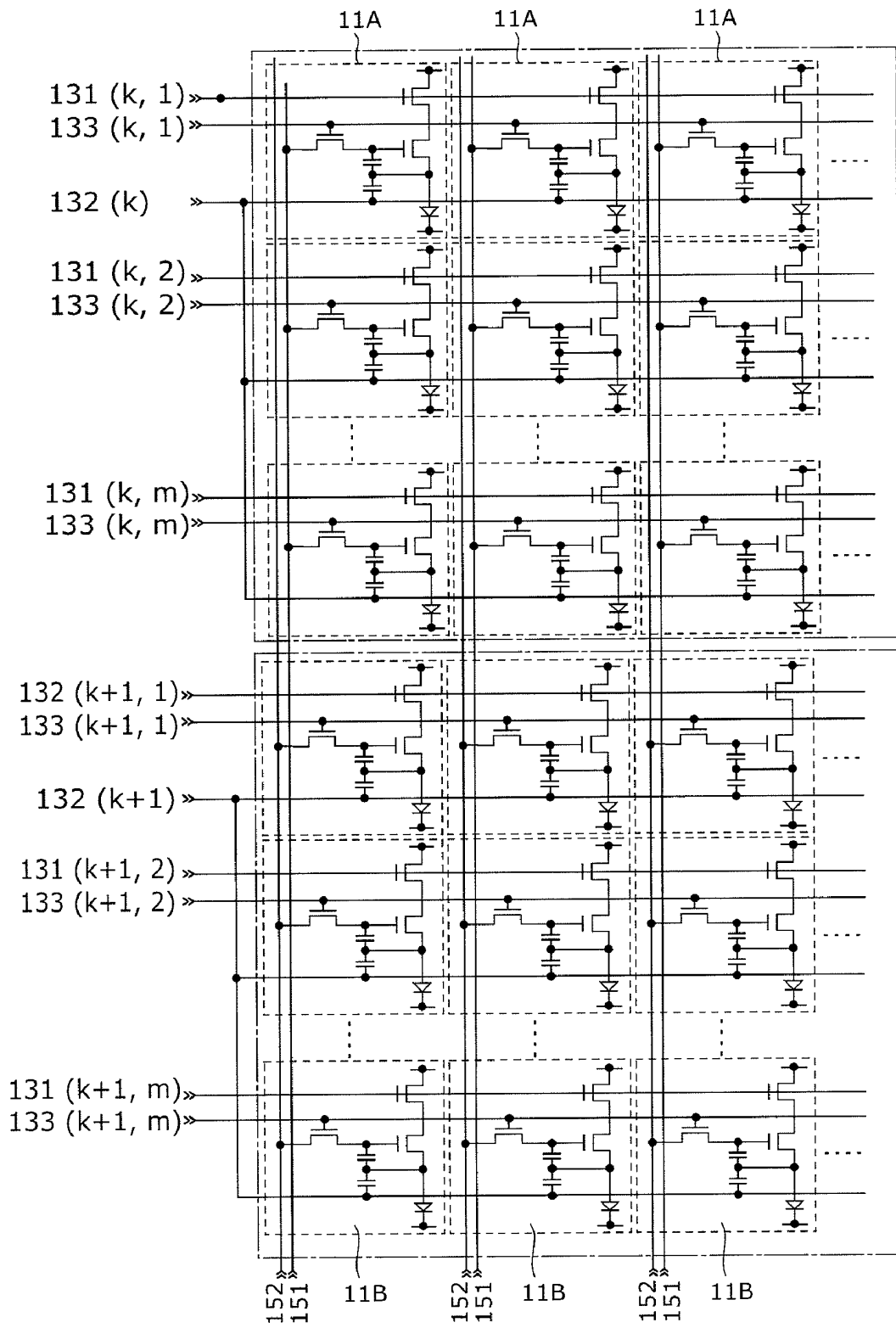

FIG. 13

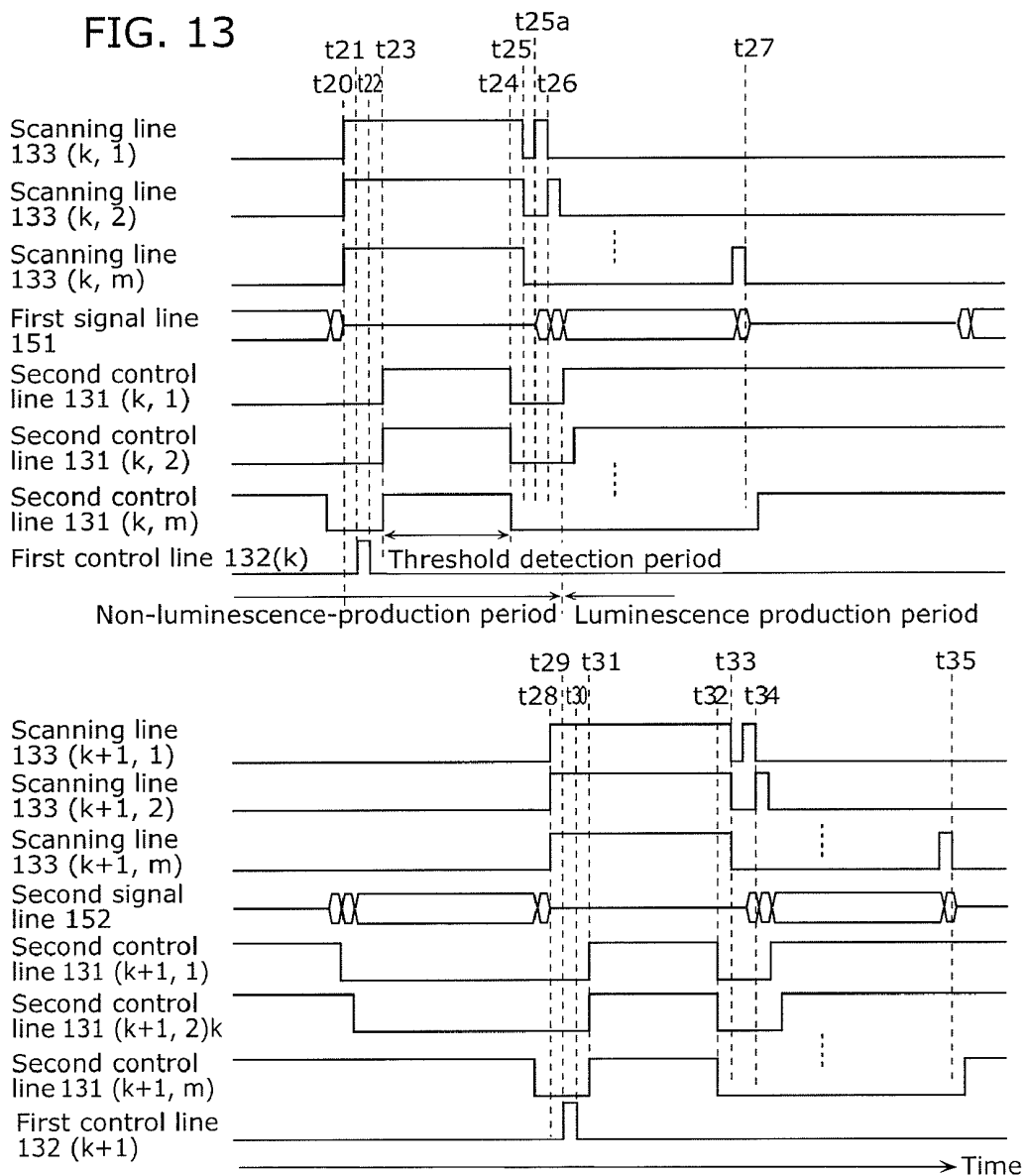

FIG. 14

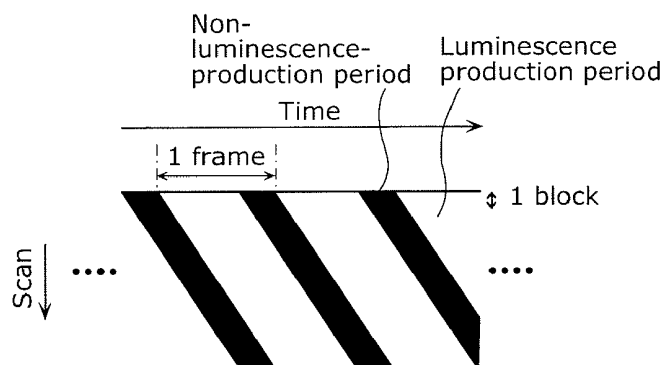

FIG. 15A

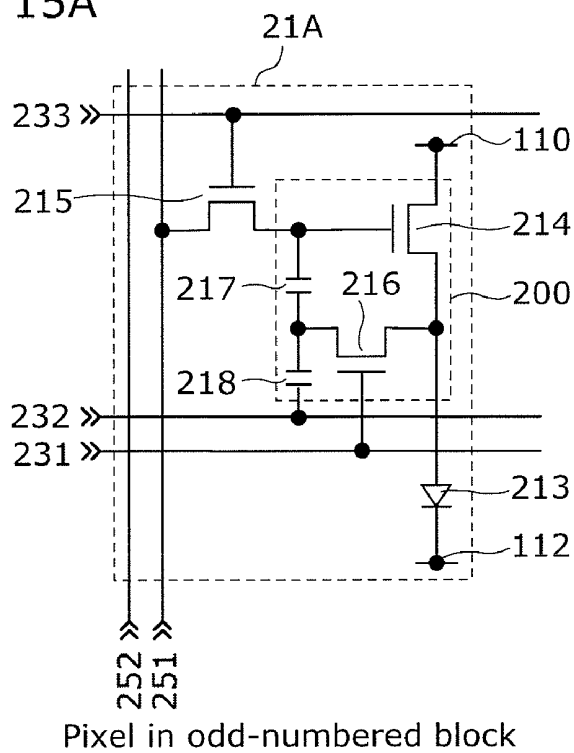

FIG. 15B

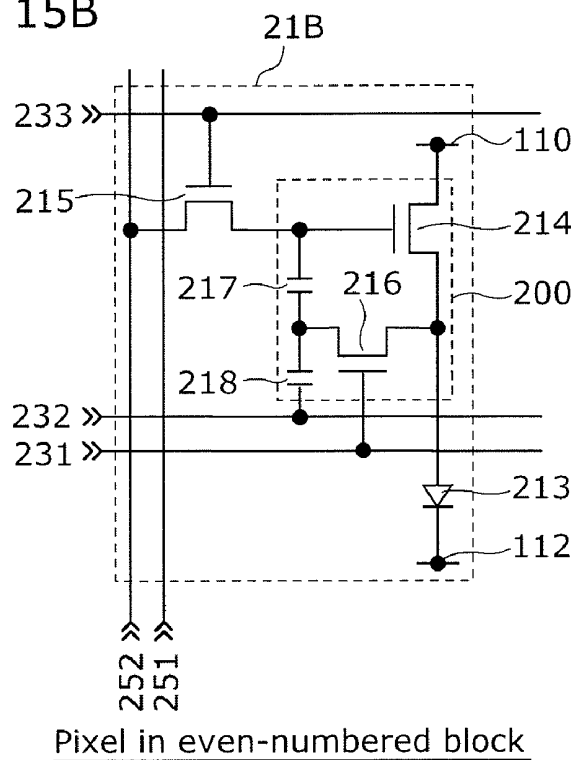

FIG. 16

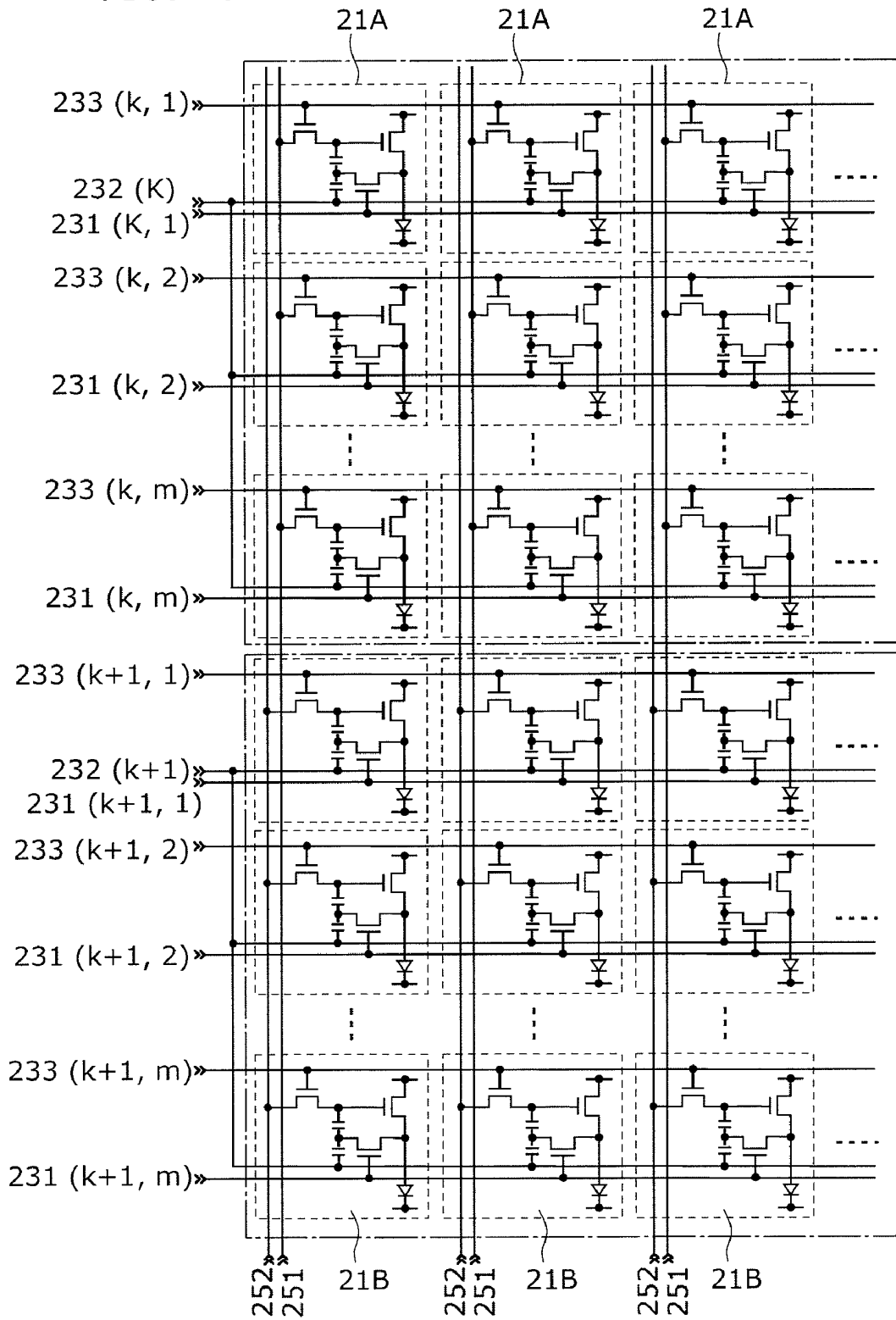
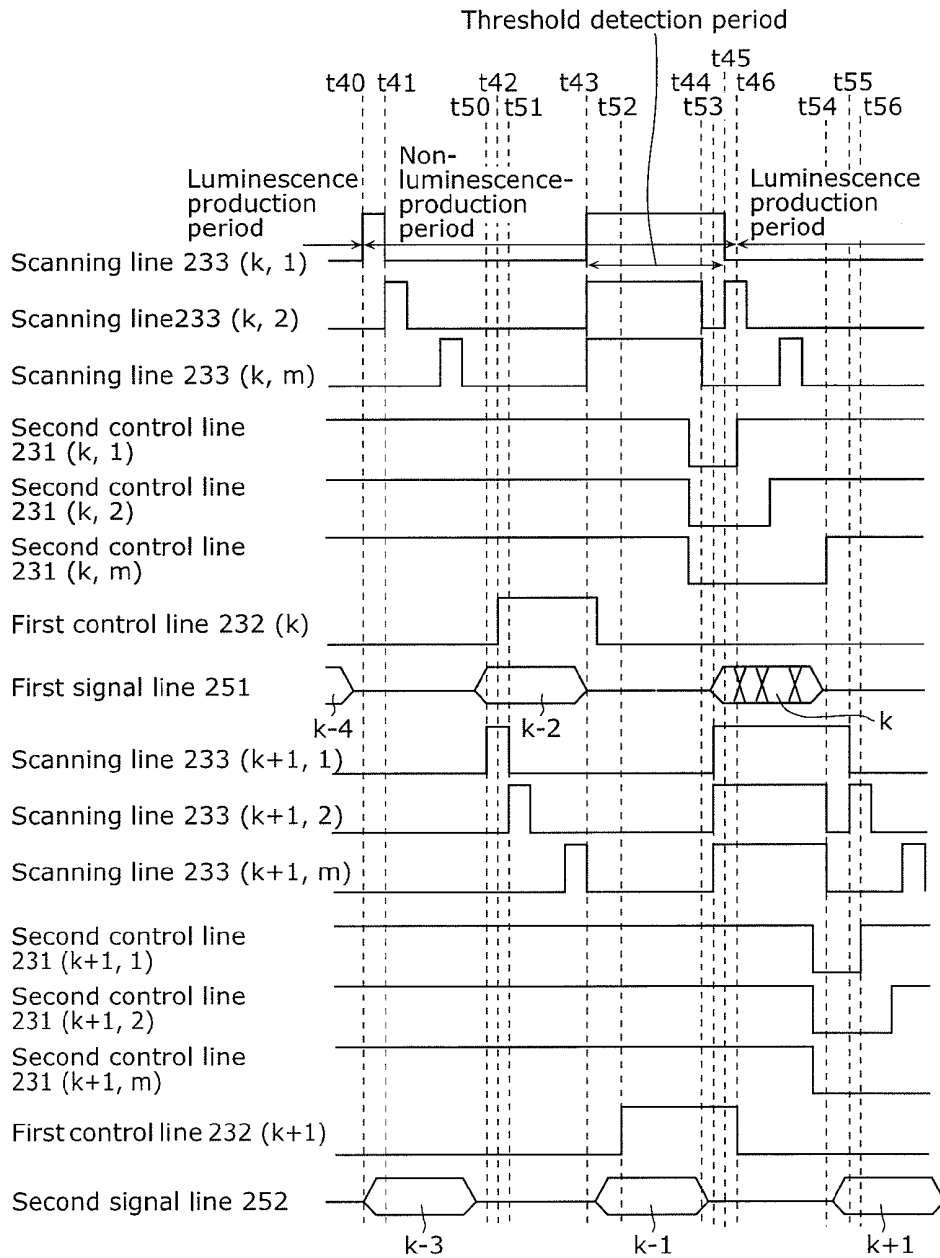

FIG. 17



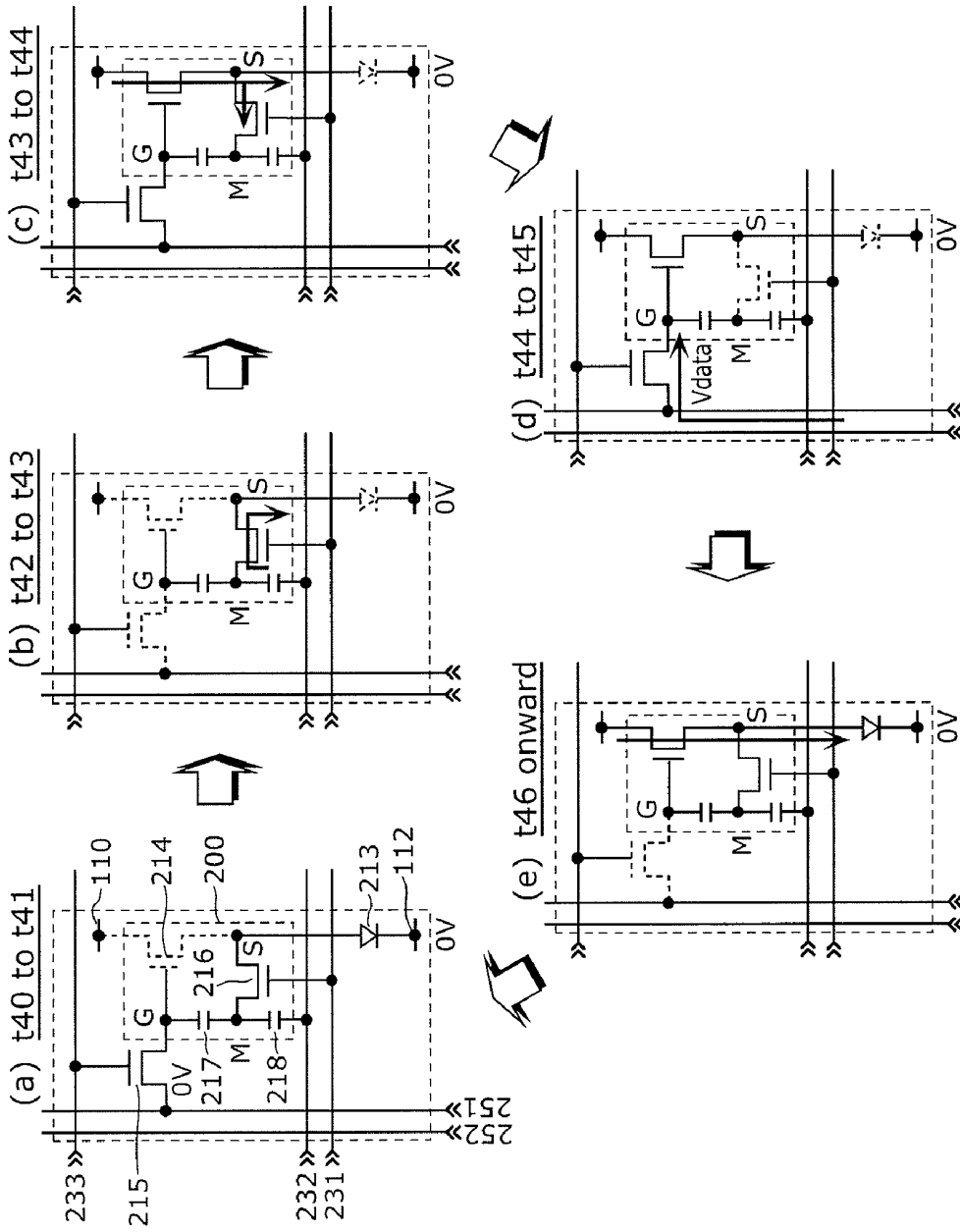

FIG. 19

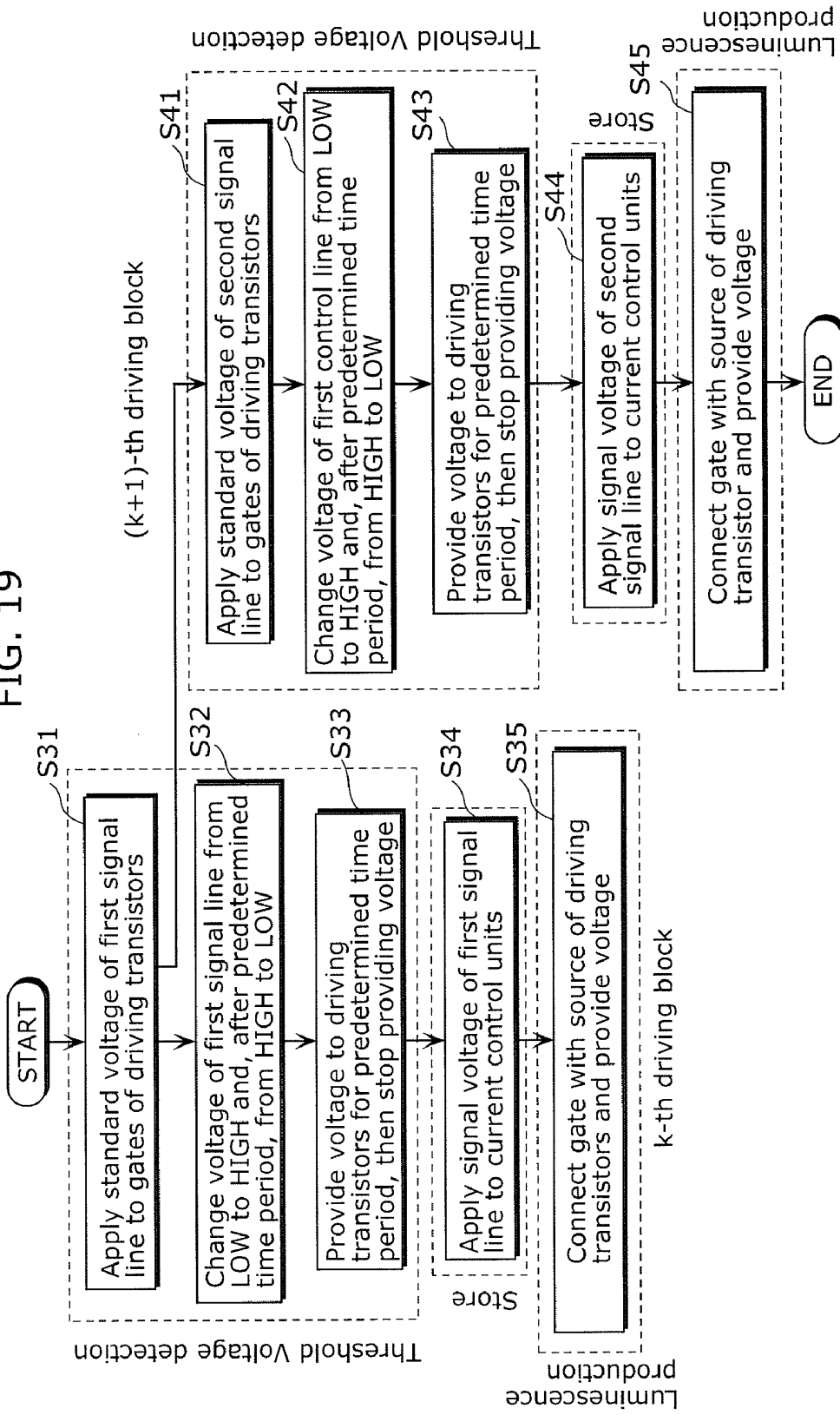

FIG. 20

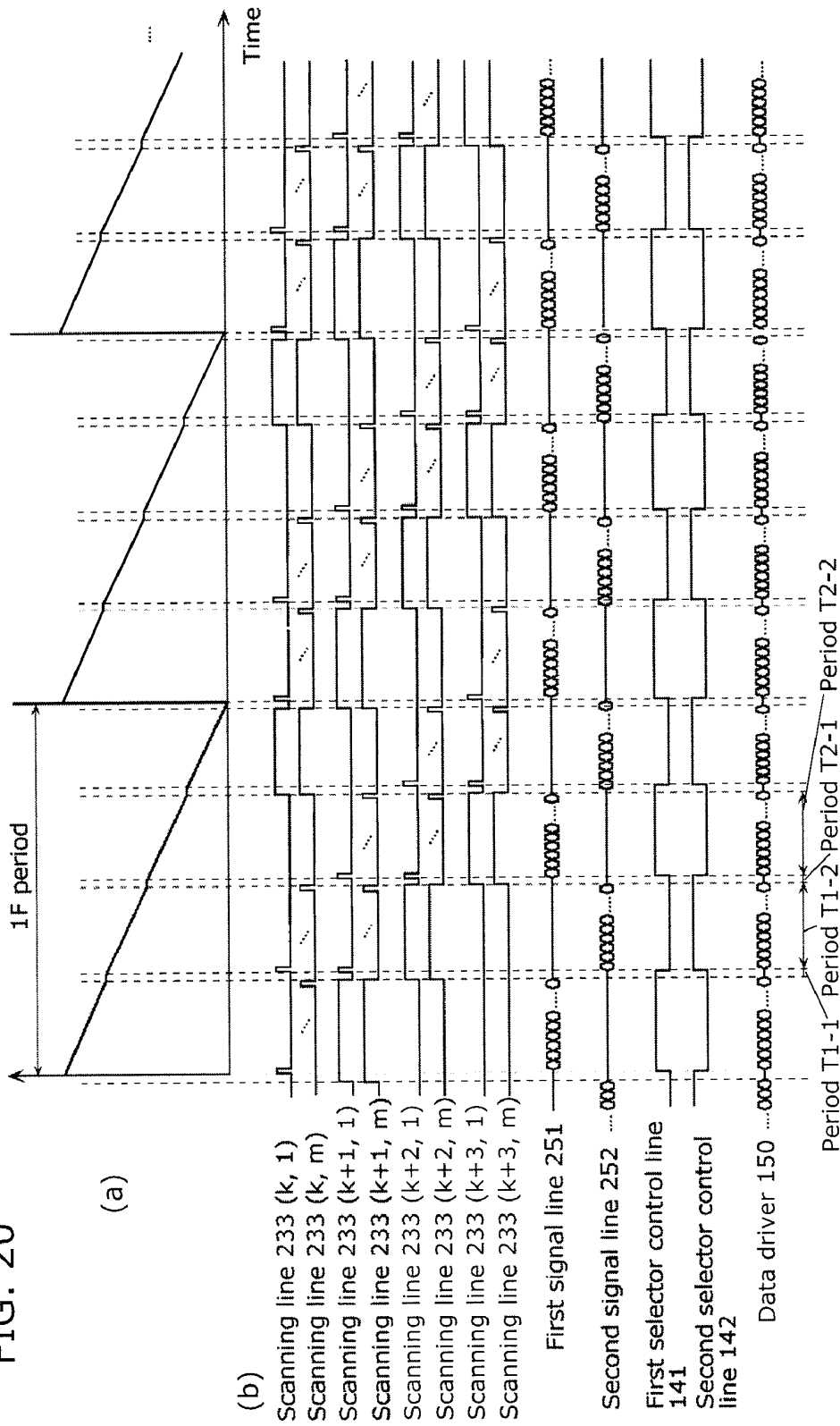
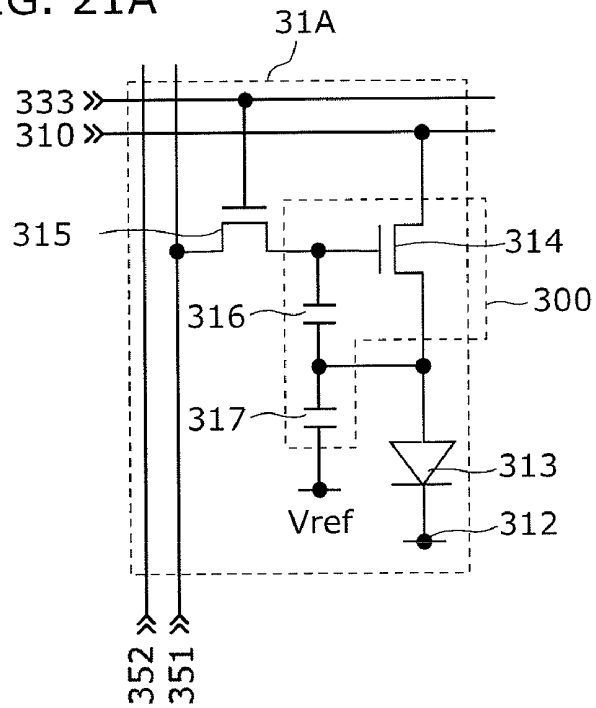
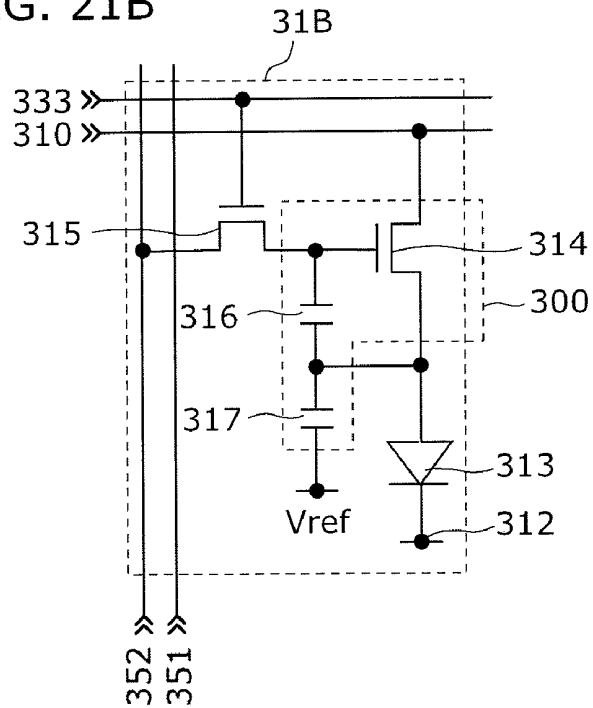

FIG. 21A



Pixel in odd-numbered block

FIG. 21B



Pixel in even-numbered block

FIG. 22

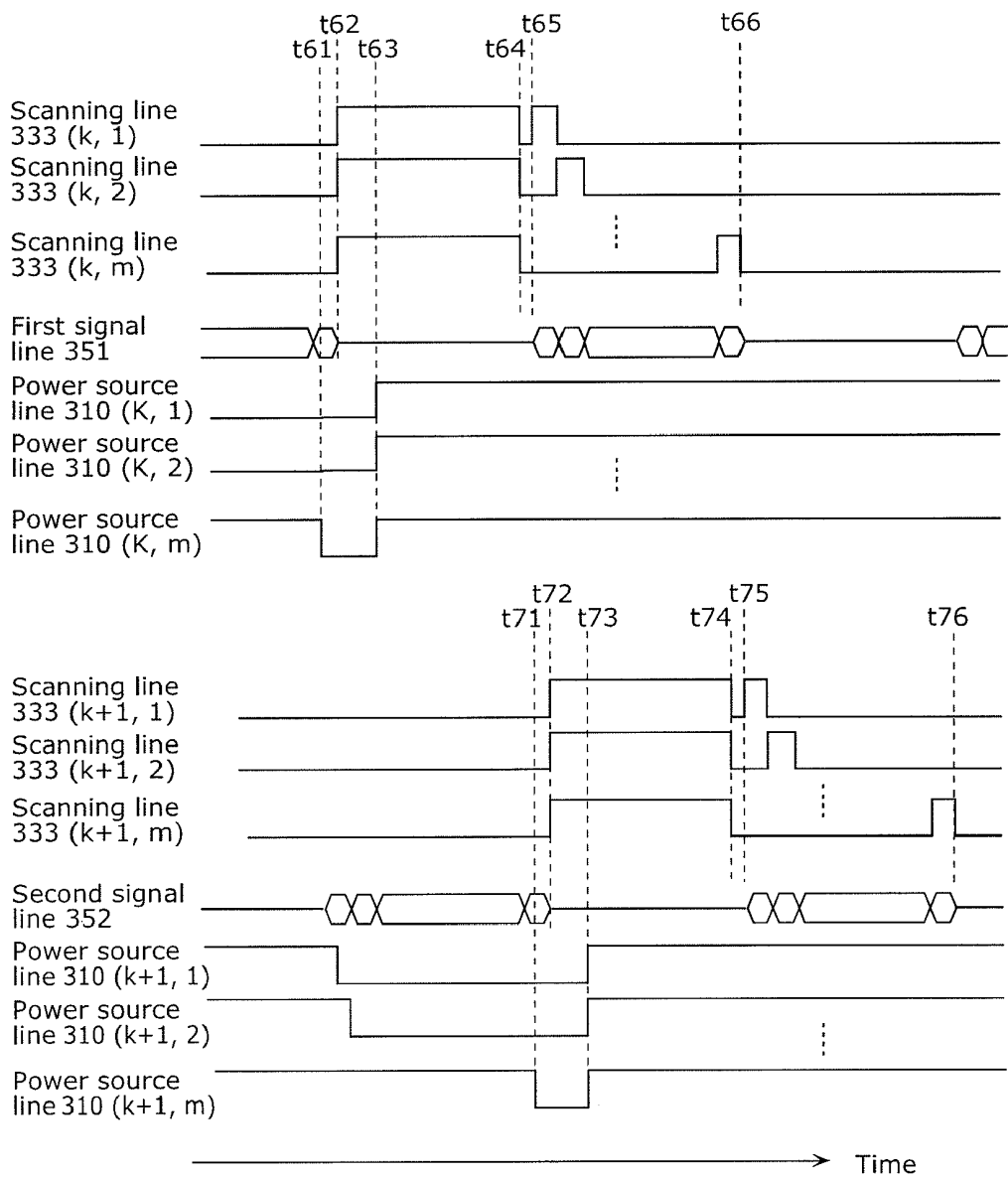

FIG. 23

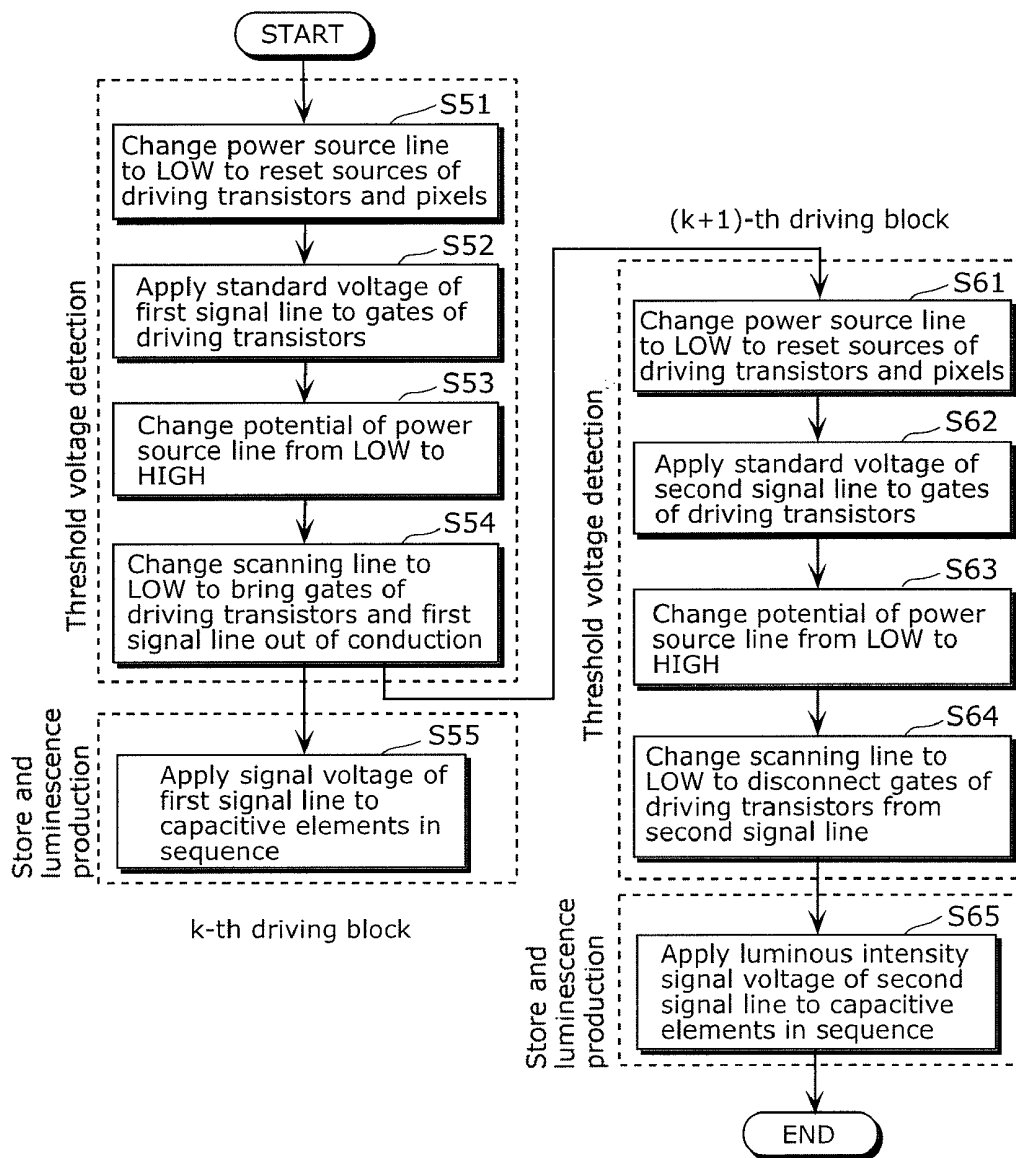

FIG. 24A

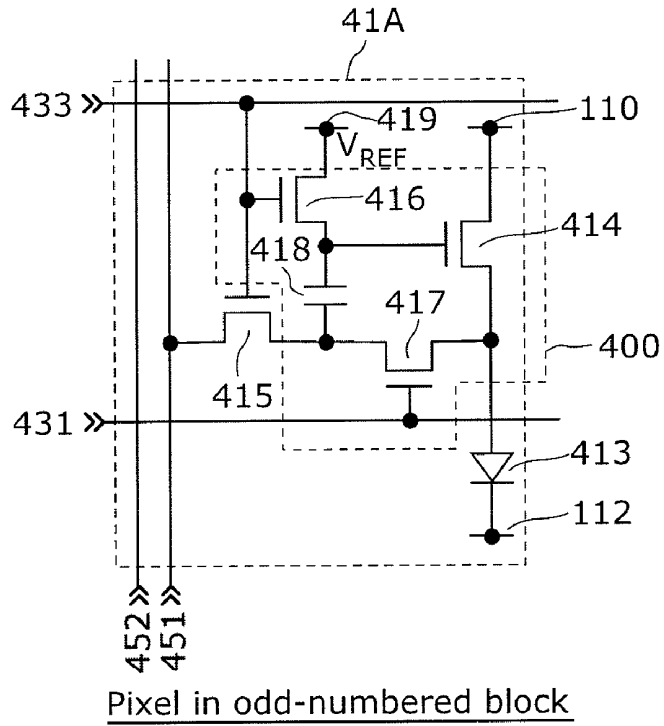

FIG. 24B

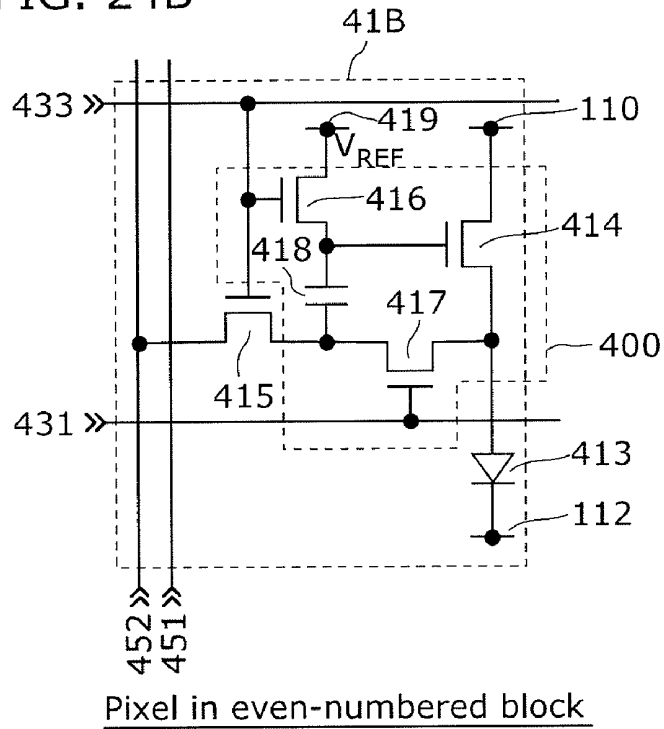

FIG. 25

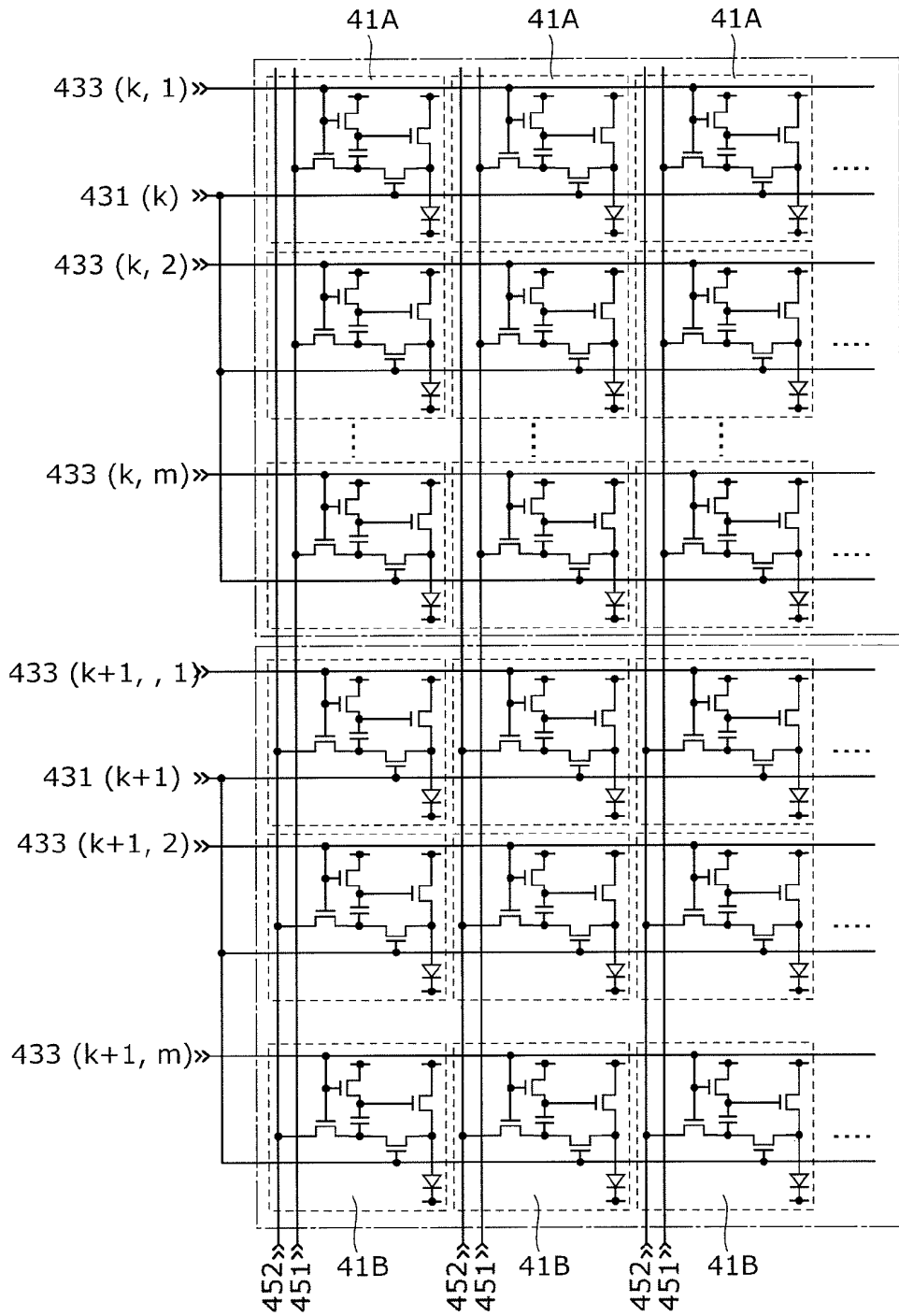

FIG. 26

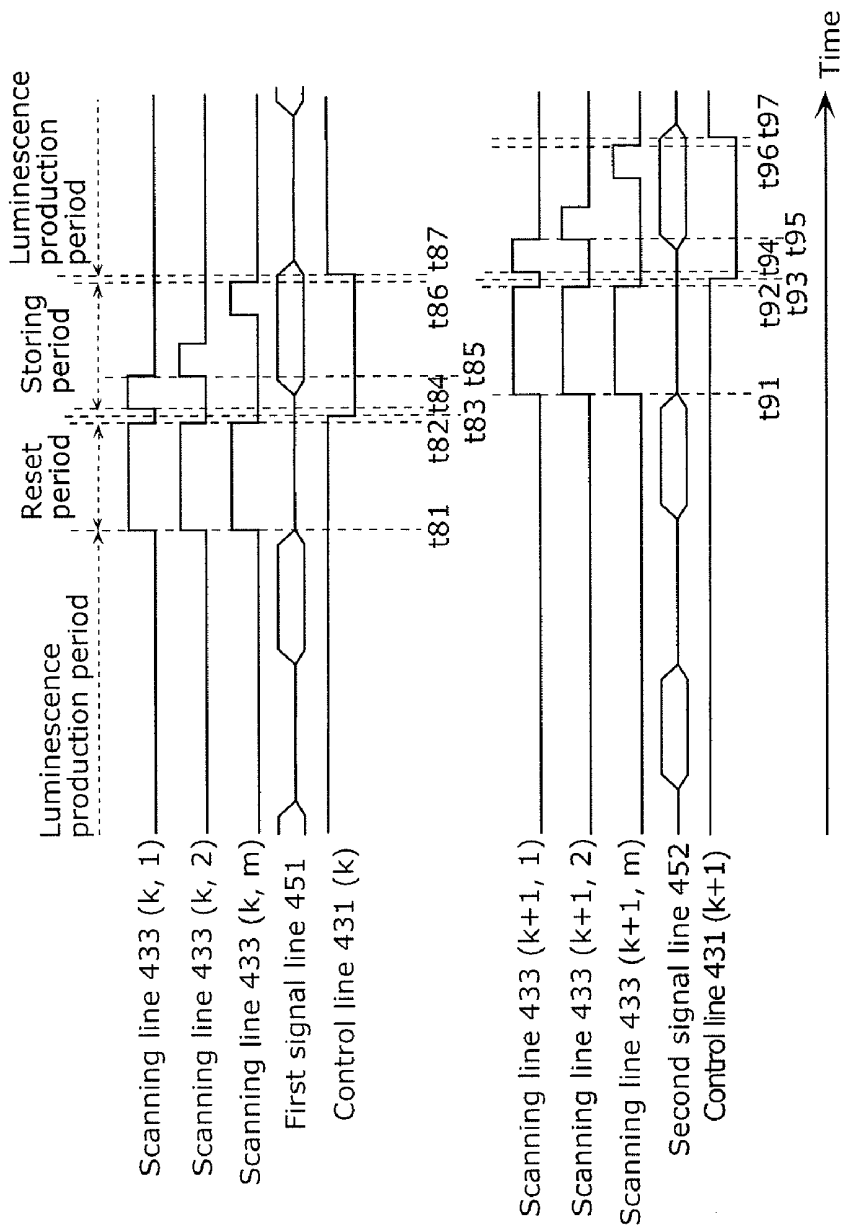

FIG. 27

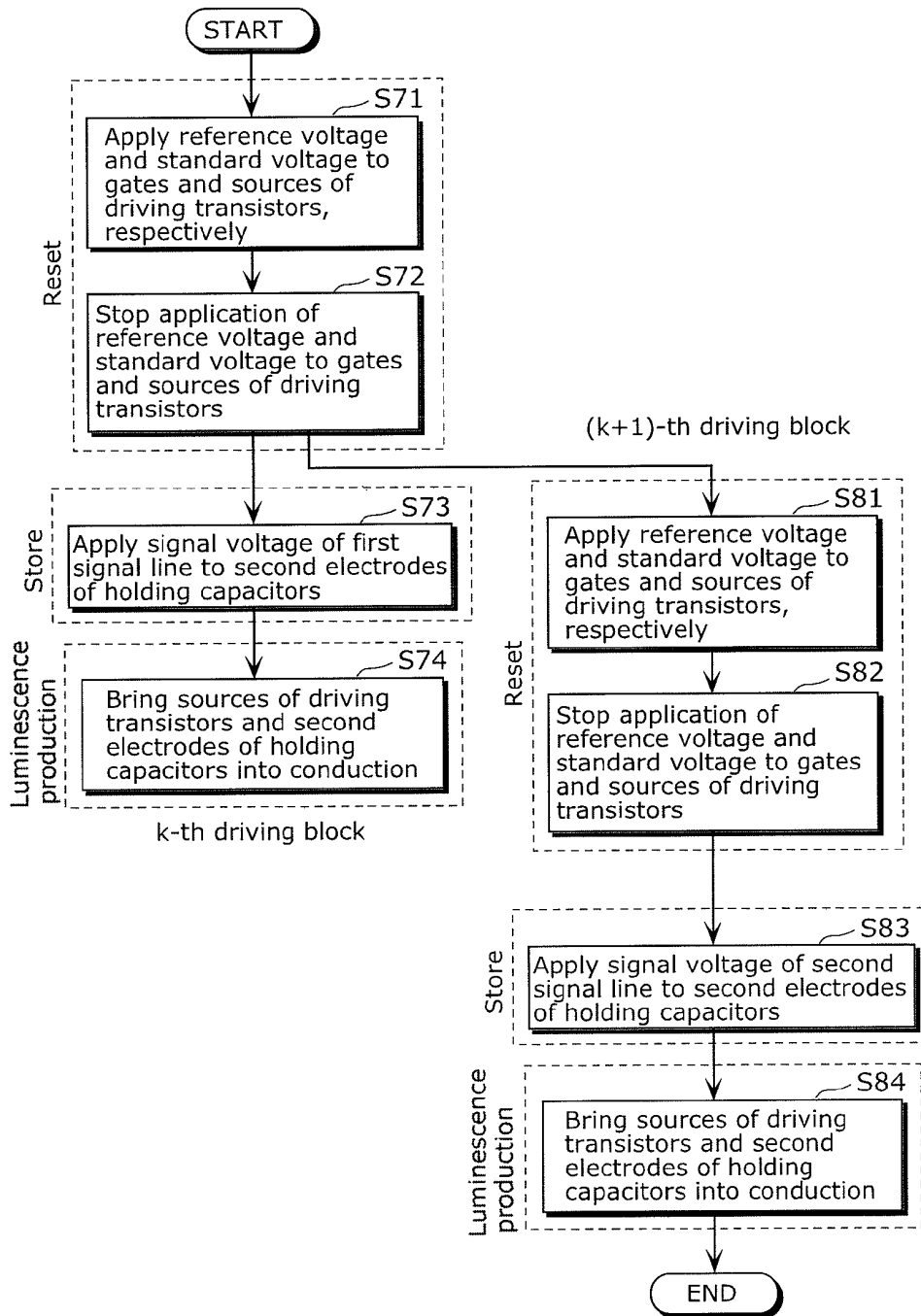

FIG. 28A

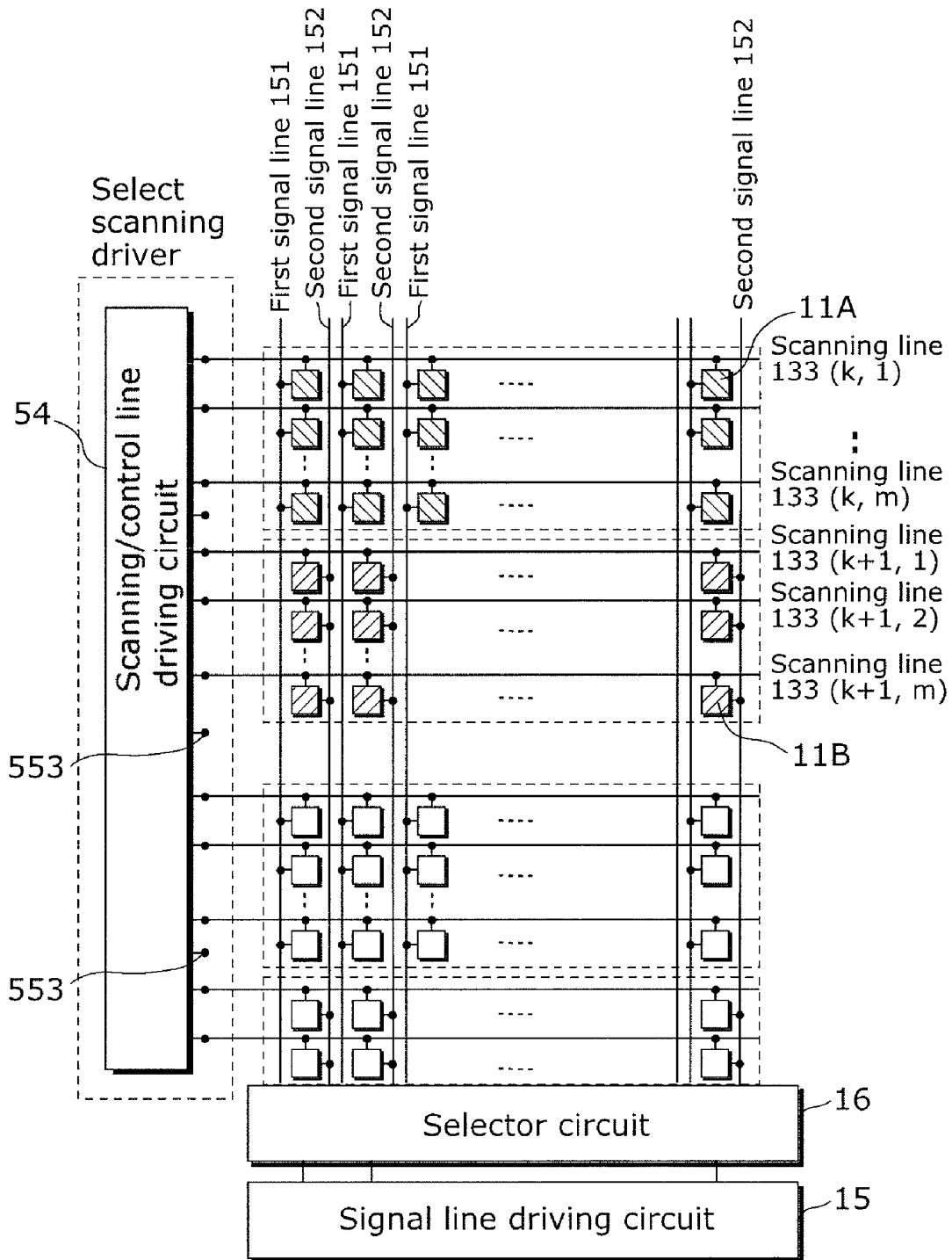

FIG. 28B

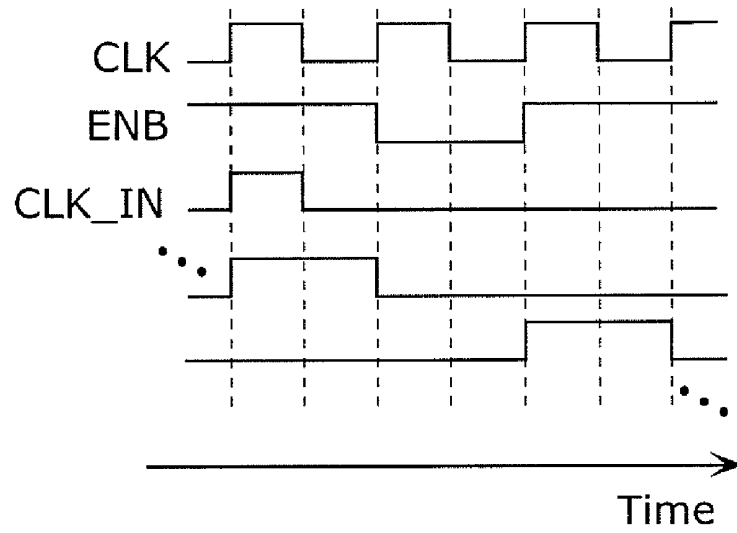

FIG. 28C

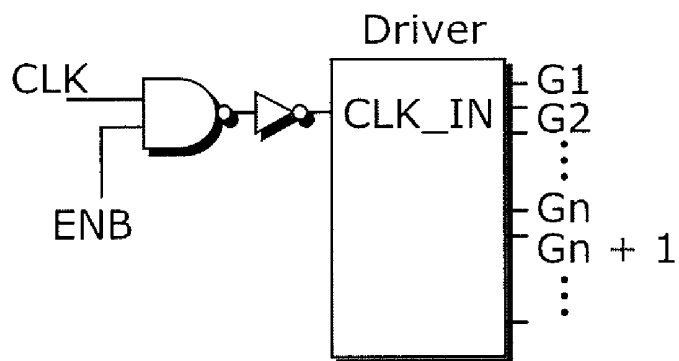

FIG. 29

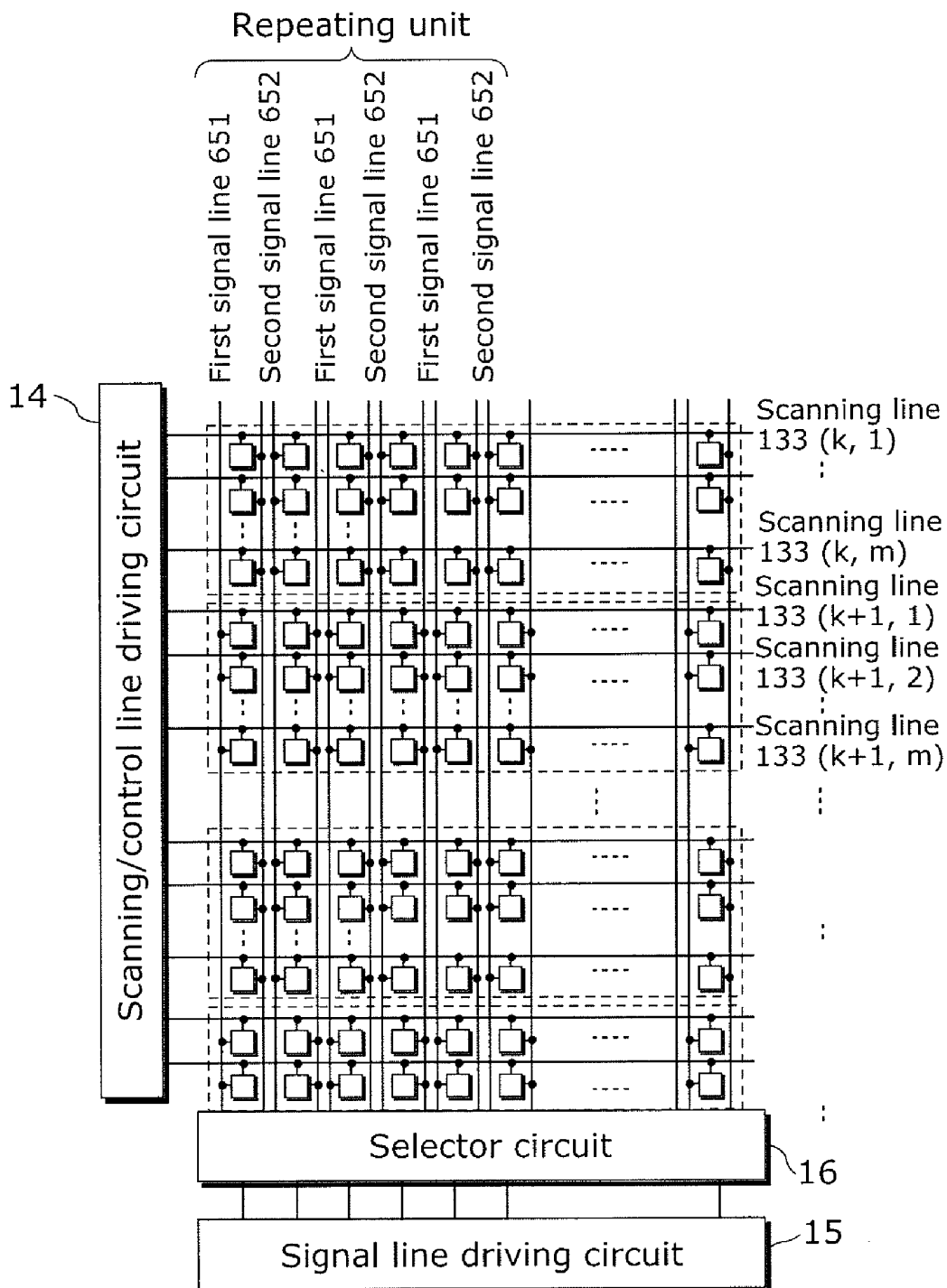

FIG. 30A

First signal line 151 Second signal line 152

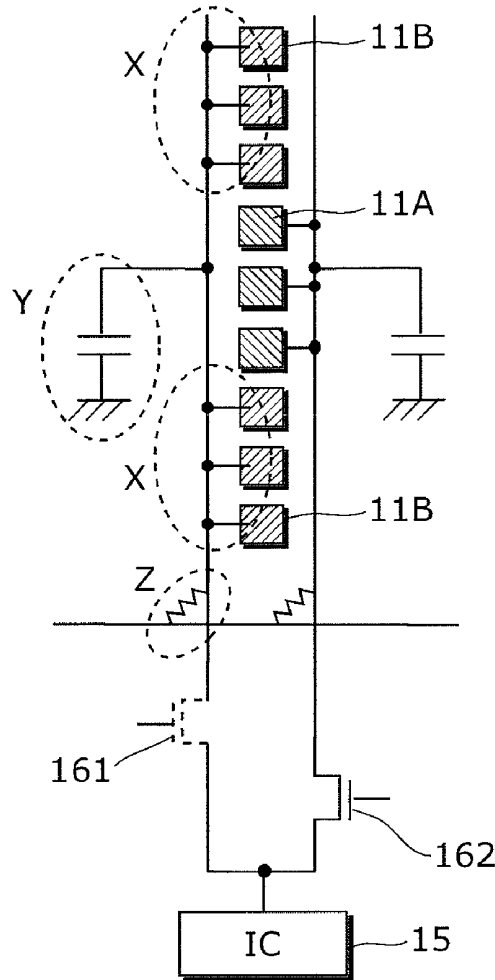

FIG. 30B

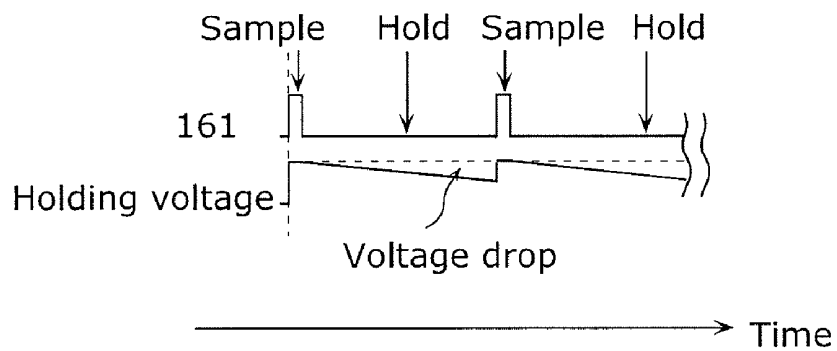

FIG. 31

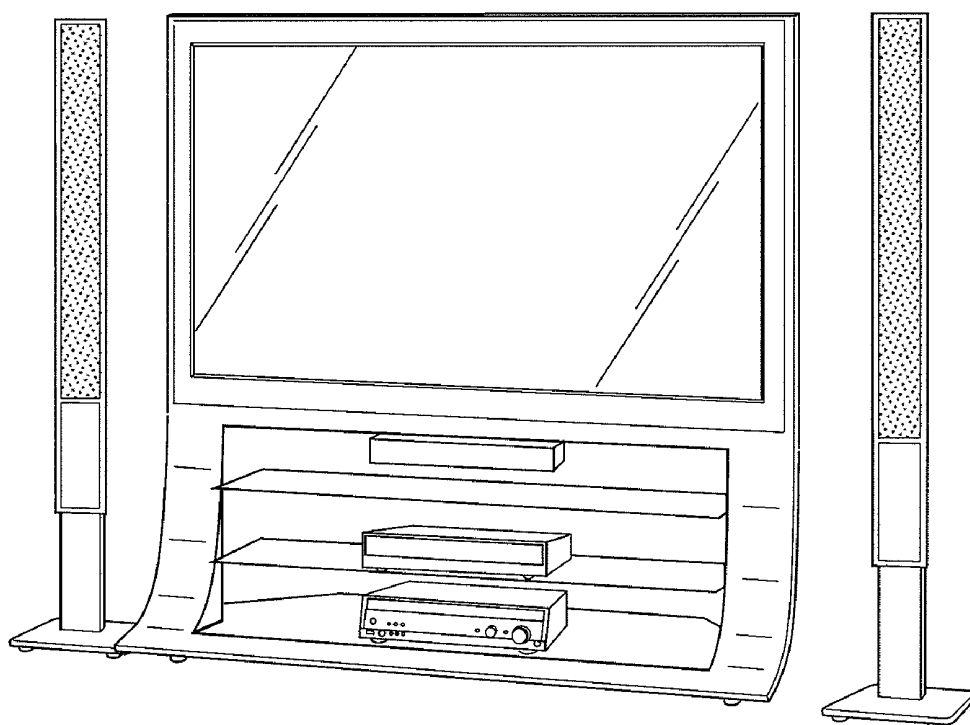

FIG. 32

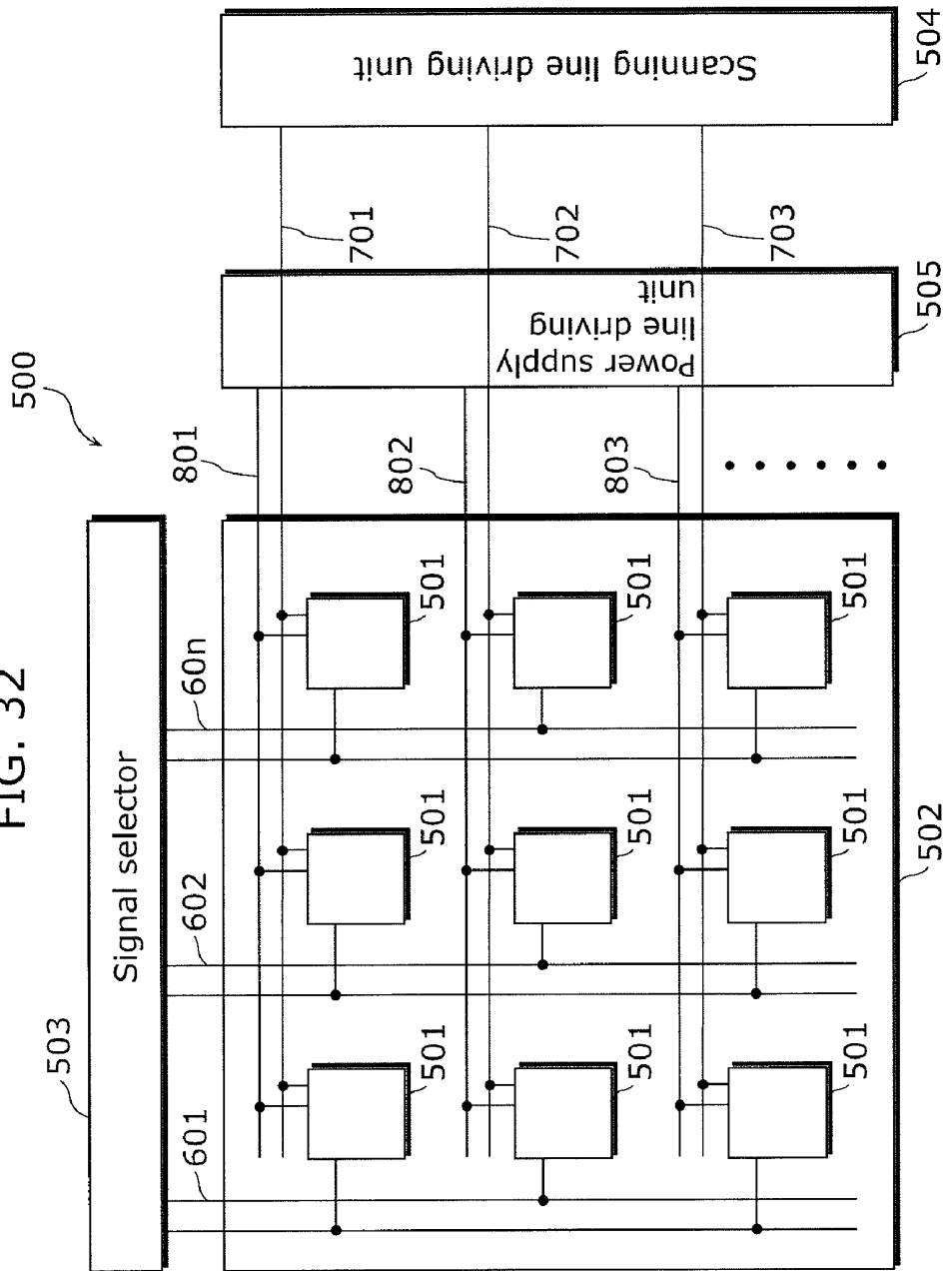

FIG. 33

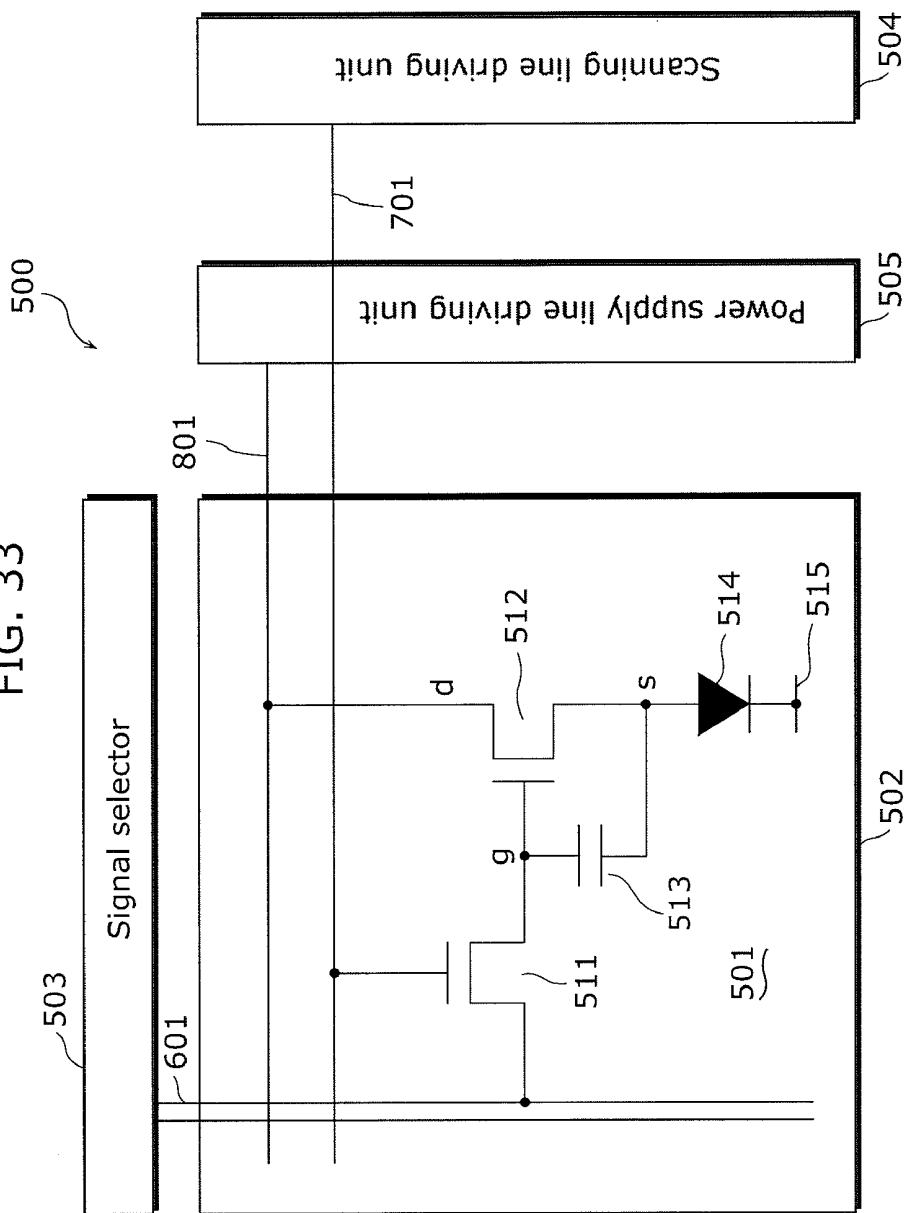
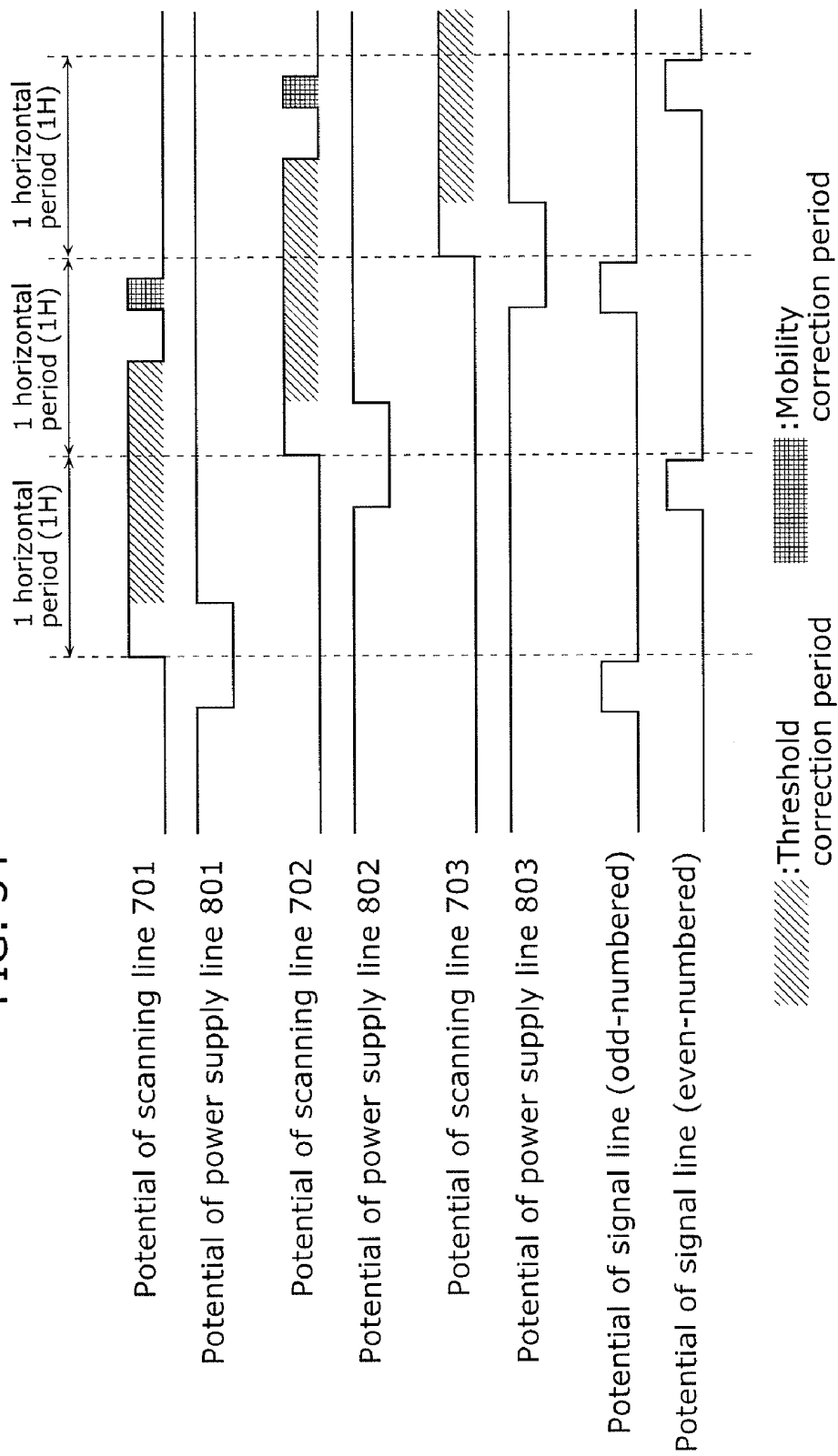

FIG. 34



DISPLAY DEVICE AND METHOD OF CONTROLLING THE SAME

CROSS REFERENCE TO RELATED APPLICATION

[0001] This is a continuation application of PCT Patent Application No. PCT/JP2010/005471 filed on Sep. 6, 2010, designating the United States of America. The entire disclosure of the above-identified applications, including specification, drawings and claims is incorporated herein by reference in its entirety.

BACKGROUND OF THE INVENTION

[0002] (1) Field of the Invention

[0003] The present invention relates to display devices and to methods of controlling the same, and particularly relates to a display device using a current-driven luminescence element and to a method of controlling the same.

[0004] (2) Description of the Related Art

[0005] Display devices using organic electroluminescence (EL) elements are well-known as display devices using current-driven luminescence elements. An organic EL display device uses such self-luminous organic EL elements, and thus does not require backlights needed in a liquid crystal display device and is best suited for increasing device thickness. Furthermore, since viewing angle is not restricted, practical application as a next-generation display device is expected. Furthermore, the organic EL elements used in the organic EL display device are different from liquid crystal cells which are controlled according to the voltage applied thereto, in that the luminance of the respective luminescence elements is controlled according to the value of the current flowing thereto.

[0006] In the organic EL display device, the organic EL elements included in the pixels are normally arranged in rows and columns. For example, in an organic EL display referred to as a passive-matrix organic EL display, an organic EL element is provided at each crosspoint between row electrodes (scanning lines) and column electrodes (data lines), and such organic EL elements are driven by applying a voltage equivalent to a data signal, between a selected row electrode and the column electrodes.

[0007] On the other hand, in an organic EL display device referred to as an active-matrix organic EL display device, a switching thin film transistor (TFT) is provided in each crosspoint between scanning lines and data lines, the gate of a driving element is connected to the switching TFT, the switching TFT is turned ON through a selected scanning line so as to input a data signal from a signal line to the driving element, and an organic EL element is driven by such driving element.

[0008] In the passive-matrix organic EL display device, only during the period in which each of the row electrodes (scanning lines) is selected does the organic EL element connected to the selected row electrode produce luminescence. In contrast, in the active-matrix organic EL display device, it is possible to cause the organic EL element to produce luminescence until a subsequent scan (selection). As such, a reduction in the luminance of the display is not incurred even when the number of scanning lines increases. Therefore, the active-matrix organic EL display device can be driven with low voltage and thus allows for reduced power consumption. However, in the active-matrix organic EL display device, due to variation in the characteristics of the

driving transistors, the current flowing to the organic EL elements are different among the respective pixels thereby causing differences in luminance even when the same data signal is supplied, and thus there is the disadvantage of the occurrence of luminance unevenness.

[0009] In response to this problem, for example, Patent Reference 1 (Japanese Unexamined Patent Application Publication No. 2008-122633) discloses a method of compensating for the variation of characteristics for each pixel using a simple pixel circuit, as a method of compensating for the luminance unevenness caused by the variation in the characteristics of the driving transistors.

[0010] FIG. 32 is a block diagram showing the configuration of a conventional display device disclosed in Patent Reference 1. An image display device 500 shown in the figure includes a pixel array unit 502 and a drive unit which drives the pixel array unit 502. The pixel array unit 502 includes scanning lines 701 to 70m disposed on a row basis, and signal lines 601 to 60n disposed on a column basis, pixels 501 each of which is disposed on a part at which both a scanning line and a signal line cross, and power supply lines 801 to 80m disposed on a row basis. Furthermore, the drive unit includes a signal selector 503, a scanning line drive unit 504, and a power supply line drive unit 505.

[0011] The scanning line drive unit 504 performs line-sequential scanning of the pixels 501 on a per row basis, by sequentially supplying control signals on a horizontal cycle (1 H) to each of the scanning lines 701 to 70m. The power supply line drive unit 505 supplies, to each of the power supply lines 801 to 80m, power source voltage that switches between a first voltage and a second voltage, in accordance with the line-sequential scanning. The signal selector 503 supplies, to the signal lines 601 to 60n that are in columns, signal voltage (image signal) and a standard voltage, switching between the two voltages in accordance with the line-sequential scanning.

[0012] Here, two each of the respective signal lines 601 to 60n in columns are disposed per column; one of the signal lines supplies the standard voltage and the signal voltage to the pixels 501 in an odd row, and the other of the signal lines supplies the standard voltage and the signal voltage to the pixels 501 in an even row.

[0013] FIG. 33 is a circuit configuration diagram for a pixel included in the conventional display device disclosed in Patent Reference 1. Here, FIG. 33 shows the pixel 501 in the first row and the first column. Furthermore, the scanning line 701, the power supply line 801, and the signal line 601 are provided to this pixel 501. It should be noted that one out of the two lines of the signal lines 601 is connected to this pixel 501. The pixel 501 includes a switching transistor 511, a driving transistor 512, a holding capacitive element 513, and a luminescence element 514. The switching transistor 511 has a gate connected to the scanning line 701, one of a source and a drain connected to the signal line 601, and the other connected to the gate of the driving transistor 512. The driving transistor 512 has a source connected to the anode of the luminescence element 514 and a drain connected to the power supply line 801. The luminescence element 514 has a cathode connected to a grounding line 515. The holding capacitive element 513 is connected to the source and gate of the driving transistor 512.

[0014] In the above-described configuration, the power supply line drive unit 505 switches the voltage of the power supply line 801, from a first voltage (high-voltage) to a second

voltage (low-voltage), when the voltage of the signal line 601 is the standard voltage. Likewise, when the voltage of the signal line 601 is the standard voltage, the scanning line drive unit 504 sets the voltage of the scanning line 701 to an “H” level and causes the switching transistor 511 to be in a conductive state so as to apply the standard voltage to the gate of the driving transistor 512 and set the source of the driving transistor 512 to the second voltage which is a reset voltage. With the above-described operation, preparation for the correction of a threshold voltage V_{th} of the driving transistor 512 is completed. Next, in the correction period before the voltage of the signal line 601 switches from the standard voltage to the signal voltage, the power supply line drive unit 505 switches the voltage of the power supply line 801, from the second voltage to the first voltage, and causes a voltage equivalent to the threshold voltage V_{th} of the driving transistor 512 to be held in the holding capacitive element 513. Next, the power supply line drive unit 505 sets the voltage of the switching transistor 511 to the “H” level and causes the signal voltage to be held in the holding capacitive element 513. Specifically, the signal voltage is added to the previously held voltage equivalent to the threshold voltage V_{th} of the driving transistor 512, and held into the holding capacitive element 513. Then, the driving transistor 512 receives a supply of current from the power supply line 801 to which the first voltage is being applied, and supplies the luminescence element 514 with a drive current corresponding to the held voltage.

[0015] In the above-described operation, the period of time during which the standard voltage is applied to the respective signal lines is prolonged through the placement of two of the signal lines 601 in every column. This secures the initialization period of the driving transistor 512 and the correction period for holding the voltage equivalent to the threshold voltage V_{th} in the holding capacitive element 513.

[0016] FIG. 34 is an operation timing chart for the display device disclosed in Patent Reference 1. The figure describes, sequentially from the top, the signal waveforms of: the scanning line 701 and the power supply line 801 of the first line; the scanning line 702 and the power supply line 802 of the second line; the scanning line 703 and the power supply line 803 of the third line; the signal line allocated to the pixel of an odd row; and the signal line allocated to the pixel of an even row. The scanning signal applied to the scanning lines sequentially shifts 1 line for every 1 horizontal period (1 H). The scanning signal applied to the scanning lines for one line includes two pulses. The time width of the first pulse is long at 1 H or more. The time width of the second pulse is narrow and is part of 1 H. The first pulse corresponds to the above-described initialization period and the threshold voltage correction period, and the second pulse corresponds to a signal voltage sampling period and a mobility correction period. Furthermore, the power source pulse supplied to the power supply lines also shifts 1 line for every 1 H cycle. In contrast, the signal voltage is applied once every 2 H to the respective signal lines, and thus it is possible to ensure that the period of time during which the standard voltage is applied is 1 H or more.

[0017] In this manner, in the conventional display device disclosed in Patent Reference 1, even when there is a variation in the threshold voltage V_{th} of the driving transistor 512 for each pixel, by ensuring a sufficient initialization period and

threshold voltage correction period, the variation is canceled on a pixel basis, and unevenness in the luminance of an image is inhibited.

SUMMARY OF THE INVENTION

[0018] However, in the conventional display device disclosed in Patent Reference 1, there is frequent turning ON and OFF of the signal level of the scanning lines and power supply lines that are provided in each of the pixel rows. For example, the reset period and the threshold voltage correction period need to be set for each of the pixel rows. Furthermore, when sampling signal voltage from a signal line via a switching transistor, luminescence production periods need to be provided successively. Therefore, the initialization period, the threshold voltage correction timing, and luminescence generation timing for each pixel row need to be set. As such, since the number of rows increases with an increase in the area of a display panel, the signals outputted from each driving circuit increases and the frequency for the signal switching thereof rises. Specifically, the signal output load of the scanning line driving circuit and the power supply line driving circuit increases.

[0019] Furthermore, the increase in the signal lines for each pixel row causes the number of outputs of the signal line driving circuit to increase, thereby causing an increase in the size and cost of the driving circuit and deterioration of manufacturing yield.

[0020] Furthermore, in the conventional display device disclosed in Patent Reference 1, the initialization period of the driving transistor and the correction period for the threshold voltage V_{th} is under 2 H, and thus there is a limitation for a display device in which high-precision correction is required.

[0021] In view of the aforementioned problem, the present invention has as an object to provide (i) a display device in which a driving transistor initialization period and a period in which the threshold voltage of the driving transistor can be precisely corrected are secured, and driving circuit output load is reduced, and (ii) a method of controlling the display device.

[0022] In order to achieve the aforementioned object, a display device according to an aspect of the present invention is a display device including pixels arranged in rows and columns, the display device including: a signal line driving circuit that selectively outputs, to an output line disposed in each of the columns, a standard voltage and a signal voltage that determines luminance of the pixels; a first signal line and a second signal line that are disposed in each of the columns, for applying the standard voltage or the signal voltage to the pixels; a selector disposed in each of the columns and configured to apply the standard voltage or the signal voltage outputted from the output line selectively to one of the first signal line and the second signal line; a first power source line and a second power source line; and a scanning line disposed in each of the rows, wherein the pixels compose at least two driving blocks each of which includes at least two of the rows, each of the pixels includes: a luminescence element that includes terminals, one of the terminals being connected to the second power source line, and the luminescence element producing luminescence according to a flow of a signal current corresponding to the signal voltage; and a current control unit connected to the first power source line and the other of the terminals of the luminescence element, and configured to convert the signal voltage applied to the current control unit into the signal current, and hold an initializing voltage or a

voltage corresponding to a threshold voltage when the standard voltage is applied to the current control unit, the initializing voltage being a voltage for initializing, each of the pixels in a k-th driving block of the driving blocks further includes a first switching transistor that includes a gate connected to the scanning line, one of a source and drain connected to the first signal line, and the other of the source and the drain connected to the current control unit, and switchably interconnects the first signal line and the current control unit, k being a positive integer, each of the pixels in a (k+1)-th driving block of the driving blocks further includes a second switching transistor that includes a gate connected to the scanning line, one of a source and a drain connected to the second signal line, and the other of the source and the drain connected to the current control unit, and switchably interconnects the second signal line and the current control unit, at least one of a threshold voltage detection period and an initializing period is provided in common for the pixels in a same one of the driving blocks, and at least one of the threshold voltage detection period and the initializing period provided in common in the same one of the driving blocks is provided independently for the pixels in different ones of the driving blocks, the threshold voltage detection period being a period during which the threshold voltage is detected when the standard voltage is applied to the current control unit, and the initializing period being a period during which the current control unit is initialized, and the display device further includes a selector control unit configured to cause the selector to, in one frame period, apply the signal voltage to the pixels in the k-th driving block via the first signal line and subsequently apply the standard voltage to the first signal line, and apply the signal voltage to the pixels in the (k+1)-th driving block via the second signal line and subsequently apply the standard voltage to the second signal line.

[0023] According to the display device and the method of controlling the same according to the present invention, the driving transistor initialization periods and the threshold voltage correction periods can be made uniform within a driving block, and thus the initialization period and the correction period can take a large part of a 1-frame period. With this, a precisely corrected drive current flows to the luminescence elements, and thus image display quality improves. In addition, the forming of driving blocks makes it possible to reduce the number of times that the signal level outputted by the driving circuit is switched in the aforementioned periods, and furthermore, with the selector provided between the signal line driving circuit and the signal lines, the number of output lines from the signal line driving circuit can be reduced. This allows for a reduction in driving circuit output load and costs as well as improved manufacturing yield.

BRIEF DESCRIPTION OF THE DRAWINGS

[0024] These and other objects, advantages and features of the invention will become apparent from the following description thereof taken in conjunction with the accompanying drawings that illustrate a specific embodiment of the invention. In the Drawings:

[0025] FIG. 1 is a block diagram illustrating an electrical configuration of a display device according to a first embodiment of the present invention;

[0026] FIG. 2A is a circuit diagram of a pixel in an odd-numbered driving block in the display device according to the first embodiment of the present invention;

[0027] FIG. 2B is a circuit diagram of a pixel in an even-numbered driving block in the display device according to the first embodiment of the present invention;

[0028] FIG. 3 is a circuit diagram of a selector circuit and its neighboring circuits in the display device according to an embodiment of the present invention;

[0029] FIG. 4 is a circuit diagram illustrating a portion of a display panel of a display device according to a first embodiment of the present invention;

[0030] FIG. 5 is a timing chart of an operation of a method for driving the display device according to the first embodiment of the present invention;

[0031] FIG. 6 is a state transition diagram of a pixel of the display device according to the first embodiment of the present invention;

[0032] FIG. 7 is a flowchart of an operation of the display device according to the first embodiment of the present invention;

[0033] FIG. 8 is a timing chart of an operation for driving a selector circuit of the display device according to the first embodiment of the present invention;

[0034] FIG. 9A is a diagram for explaining a state in a certain period in which a standard voltage is provided from the signal line driving circuit 15 to a first signal line 151;

[0035] FIG. 9B is a diagram for explaining a state in a certain period in which a signal voltage is provided from the signal line driving circuit 15 to a second signal line 152;

[0036] FIG. 9C is a diagram for explaining a state in a certain period in which the standard voltage is provided from the signal line driving circuit 15 to the second signal line 152;

[0037] FIG. 9D is a diagram for explaining a state in a certain period in which a signal voltage is provided from the signal line driving circuit 15 to the first signal line 151;

[0038] FIG. 10 is a diagram illustrating waveform characteristics of a scanning line and a signal line;

[0039] FIG. 11 is a state transition diagram of a driving block which is producing luminescence by a driving method according to the first embodiment of the present invention;

[0040] FIG. 12 is a circuit diagram illustrating a portion of a display panel of a display device according to a second embodiment of the present invention;

[0041] FIG. 13 is a timing chart of an operation of a method for driving the display device according to the second embodiment of the present invention;

[0042] FIG. 14 is a state transition diagram of a driving block which is producing luminescence by the driving method according to the second embodiment of the present invention;

[0043] FIG. 15A is a circuit diagram specifically illustrating a pixel in an odd-numbered driving block in an display device according to a third embodiment of the present invention;

[0044] FIG. 15B is a circuit diagram specifically illustrating a pixel in an even-numbered driving block in the display device according to the third embodiment of the present invention;

[0045] FIG. 16 is a circuit diagram illustrating a portion of a display panel of the display device according to the third embodiment of the present invention;

[0046] FIG. 17 is a timing chart of an operation of a method for driving the display device according to the third embodiment of the present invention;

[0047] FIG. 18 is a state transition diagram of a pixel of the display device according to the third embodiment of the present invention;

[0048] FIG. 19 is a flowchart of an operation of the display device according to the third embodiment of the present invention;

[0049] FIG. 20 is a timing chart of an operation for driving a selector circuit of the display device according to the third embodiment of the present invention;

[0050] FIG. 21A is a circuit diagram specifically illustrating a pixel in an odd-numbered driving block in a display device according to a fourth embodiment of the present invention;

[0051] FIG. 21B is a circuit diagram specifically illustrating a pixel in an even-numbered driving block in the display device according to the fourth embodiment of the present invention;

[0052] FIG. 22 is a timing chart of an operation of a method for driving the display device according to the fourth embodiment of the present invention;

[0053] FIG. 23 is a flowchart of an operation of the display device according to the fourth embodiment of the present invention;

[0054] FIG. 24A is a circuit diagram specifically illustrating a pixel in an odd-numbered driving block in a display device according to a fifth embodiment of the present invention;

[0055] FIG. 24B is a circuit diagram specifically illustrating a pixel in an even-numbered driving block in the display device according to the fifth embodiment of the present invention;

[0056] FIG. 25 is a circuit diagram illustrating a portion of a display panel of the display device according to the fifth embodiment of the present invention;

[0057] FIG. 26 is a timing chart of an operation of a method for driving the display device according to the fifth embodiment of the present invention;

[0058] FIG. 27 is a flowchart of an operation of a display device according to the fifth embodiment of the present invention;

[0059] FIG. 28A is a block diagram illustrating an exemplary electrical configuration of a display device according to the present invention;

[0060] FIG. 28B is a diagram illustrating an example of a clock signal inputted into a scanning/control line driving circuit;

[0061] FIG. 28C is a diagram illustrating an exemplary configuration of a clock circuit for inputting a clock into the scanning/control line driving circuit;

[0062] FIG. 29 is a block diagram illustrating another exemplary electrical configuration of the display device according to the present invention;

[0063] FIG. 30A is a diagram for explaining a voltage drop in a HOLD period;

[0064] FIG. 30B is a diagram for explaining a method for minimizing an influence of a voltage drop;

[0065] FIG. 30C is a block diagram illustrating another exemplary electrical configuration of the display device according to the present invention;

[0066] FIG. 31 is a schematic view of a thin flat TV incorporating a display device of the present invention;

[0067] FIG. 32 is a block diagram illustrating a configuration of a conventional display device described in Japanese Unexamined Patent Application Publication No. 2008-122633;

[0068] FIG. 33 is a circuit diagram of a pixel of the conventional display device described in Japanese Unexamined Patent Application Publication No. 2008-122633; and

[0069] FIG. 34 is a timing chart of an operation of the display device described in Japanese Unexamined Patent Application Publication No. 2008-122633.

DESCRIPTION OF THE PREFERRED EMBODIMENT(S)

[0070] A display device in a first embodiment is a display device including pixels arranged in rows and columns, the display device including: a signal line driving circuit that selectively outputs, to an output line disposed in each of the columns, a standard voltage and a signal voltage that determines luminance of the pixels; a first signal line and a second signal line that are disposed in each of the columns, for applying the standard voltage or the signal voltage to the pixels; a selector disposed in each of the columns, for applying the standard voltage or the signal voltage outputted from the output line selectively to one of the first signal line and the second signal line; a first power source line and a second power source line; and a scanning line disposed in each of the rows, wherein the pixels compose at least two driving blocks each of which includes at least two of the rows, each of the pixels includes: a luminescence element that includes terminals, one of the terminals being connected to the second power source line, and the luminescence element producing luminescence according to a flow of a signal current corresponding to the signal voltage; and a current control unit connected to the first power source line and the other of the terminals of the luminescence element, and configured to convert the signal voltage applied to the current control unit into the signal current, and hold an initializing voltage or a voltage corresponding to a threshold voltage when the standard voltage is applied to the current control unit, the initializing voltage being a voltage for initializing, each of the pixels in a k-th driving block of the driving blocks further includes a first switching transistor that includes a gate connected to the scanning line, one of a source and drain connected to the first signal line, and the other of the source and the drain connected to the current control unit, and switchably interconnects the first signal line and the current control unit, k being a positive integer, each of the pixels in a (k+1)-th driving block of the driving blocks further includes a second switching transistor that includes a gate connected to the scanning line, one of a source and a drain connected to the second signal line, and the other of the source and the drain connected to the current control unit, and switchably interconnects the second signal line and the current control unit, at least one of a threshold voltage detection period and an initializing period is provided in common for the pixels in a same one of the driving blocks, and at least one of the threshold voltage detection period and the initializing period provided independently for the pixels in different ones of the driving blocks, the threshold voltage detection period being a period during which the threshold voltage is detected when the standard voltage is applied to the current control unit, and the initializing period being a period during which the current control unit is initialized, and the display device further

includes a selector control unit configured to cause the selector to, in one frame period, apply the signal voltage to the pixels in the k-th driving block via the first signal line and subsequently apply the standard voltage to the first signal line, and apply the signal voltage to the pixels in the (k+1)-th driving block via the second signal line and subsequently apply the standard voltage to the second signal line.

[0071] According to this aspect, the threshold voltages of the driving transistors in a driving block can be corrected in the same correction period and/or the driving transistors in a driving block can be initialized in the same period and timing. Consequently, the frequency of switching from on to off or off to on of the level of a signal provided from the scanning line, the signal line and the power source line to the pixel circuits can be reduced and accordingly the load on the driving circuit that drives the pixel circuits can be reduced. Furthermore, the grouping into driving blocks and the two signal lines disposed in each pixel column enable a large part of one frame time to be allocated to a threshold voltage correction period and/or initialization period for the driving transistors. Therefore, a highly accurate driving current flows into the pixels and the display quality is improved accordingly.

[0072] Furthermore, since a single output line of the signal line driving circuit is provided for the two signal lines disposed in one pixel column, the signal line driving circuit can be reduced in size. The reduction of the number of the output lines can reduce the cost of the driving circuit and improve panel manufacturing yield.

[0073] In addition, a parasitic capacitance of a signal line, for example, may be used to provide the standard voltage for threshold detection or other purposes to the pixels, thereby eliminating the need for providing an extra circuit for providing the standard voltage in a periphery of the panel. Accordingly, the width of a frame of the panel can be reduced and the manufacturing yield of the panel can be improved.

[0074] Furthermore, in a display device according to an aspect of the present invention, the selector control unit may be configured to cause the standard voltage to be held in a parasitic capacitance of each of the first signal line and the second signal line when the selector control unit applies the standard voltage to the first signal line and the second signal line.

[0075] According to this aspect, since the parasitic capacitances of the signal lines are used to provide the standard voltage for threshold detection or other purposes to the pixels, an extra circuit for providing the standard voltage does not need to be provided in a periphery of the panel. Accordingly, the width of the frame of the panel can be reduced and the manufacturing yield of the panel can be improved.

[0076] Furthermore, a display device according to an aspect of the present invention may further include a first control line disposed in each of the rows, and connected to the current control unit, wherein the first control line may be connected to the pixels in the same one of the driving blocks and not connected to the pixels in the different ones of the driving blocks.

[0077] According to this aspect the first control signal can be driven at the same timing in a driving block. Accordingly, the load on the driving circuit that outputs a signal that controls a driving current flowing into pixels is reduced. Furthermore, the grouping into driving blocks and the two signal lines disposed in each pixel column enable a large part of one frame time to be allocated to a control operation period of the current control unit through the first control line. Therefore, a

highly accurate driving current flows into the pixels and the display quality is improved accordingly.

[0078] Furthermore, a display device according to an aspect of the present invention may further include a second control line disposed in each of the rows, and connected to the current control unit, wherein the current control unit may include: a driving transistor that includes a gate, a source, and a drain, one of the source and the drain being connected to the other of the terminals of the luminescence element, and the driving transistor converting the signal voltage applied between the gate and the source of the driving transistor into the signal current which is a drain current of the driving transistor; a first capacitive element that includes terminals, one of the terminals being connected to the gate of the driving transistor, and the other of the terminals being connected to the source of the driving transistor; a second capacitive element that includes terminals, one of the terminals being connected to the source of the driving transistor, and the other of the terminals being connected to the first control line; and a third switching transistor that includes a gate connected to the second control line, and a source and a drain that are inserted between the first power source line and the other of the terminals of the luminescence element, and switches between ON and OFF states of the drain current of the driving transistor, the other of the source and the drain of the first switching transistor may be connected to the gate of the driving transistor, and the other of the source and the drain of the second switching transistor may be connected to the gate of the driving transistor.

[0079] According to this aspect, the current control unit includes a driving transistor which converts a signal voltage to a signal current, a first capacitive element which holds voltages corresponding to a signal voltage and a standard voltage, a second capacitive element which stabilizes the gate and source potentials of the driving transistor, and a third switching transistor which turns on and off a drain current. The circuit configuration of the current control unit, the disposition of the control line, the scanning line, and the signal line in the pixels grouped into driving blocks enable threshold voltages of the driving transistors in the same driving block to be corrected in the same period and at the same timing. Accordingly, the load on the driving circuit that outputs a signal controlling a current path to control a signal voltage is reduced. Furthermore, the grouping into driving blocks and the two signal lines disposed in each pixel column enable a large part of one frame time T_f during which all pixels are refreshed to be allocated to the threshold voltage correction period for the driving transistors. This is because a threshold voltage correction period for the (k+1)-th driving block is provided in a period during which a luminance signal is being sampled in the k-th driving block. Thus, the threshold voltage correction period is divided among the driving blocks, rather than being divided among the pixel rows. Accordingly, as the display area increases, a longer threshold voltage correction period can be set relative to one frame time without reducing the luminescence production duty cycle. Consequently, a driving current based on a signal voltage accurately corrected flows into the luminescence elements, thereby improving display quality. Furthermore, the luminescence production operation of the luminescence elements can be controlled by the third switching transistor independently of the timing of application of a signal voltage to the driving transistors.

[0080] Furthermore, in a display device according to an aspect of the present invention, the second control line may be

connected to the pixels in the same one of the driving blocks and not connected to the pixels in the different ones of the driving blocks.

[0081] According to this configuration, simultaneous luminescence production in the same block can be achieved by simultaneously controlling the third switching transistors in the same block through the second control line. Consequently, the load on the driving circuit which outputs a signal through the second control line is reduced.

[0082] Furthermore, a display device according to an aspect of the present invention may further include a second control line disposed in each of the rows, wherein the current control unit may include: a driving transistor that includes a gate, a source, and a drain, one of the source and the drain being connected to the other of the terminals of the luminescence element, and the driving transistor converting the signal voltage applied between the gate and the source of the driving transistor into the signal current which is a drain current of the driving transistor; a third capacitive element that includes terminals, one of the terminals being connected to the gate of the driving transistor, and the other of the terminals being connected to the source of the driving transistor; a fourth capacitive element that includes terminals, one of the terminals being connected to the source of the driving transistor, and the other of the terminals being connected to the first control line; and a fourth switching transistor that includes a gate connected to the second control line, one of a source and a drain connected to the other of the terminals of the third capacitive element, and the other of the source and drain connected to the source of the driving transistor, the other of the source and the drain of the first switching transistor may be connected to the gate of the driving transistor, and the other of the source and the drain of the second switching transistor may be connected to the gate of the driving transistor.

[0083] According to this aspect, the current control unit includes a driving transistor which converts a signal voltage to a signal current, a third capacitive element which holds voltages corresponding to a signal voltage and a standard voltage, a fourth capacitive element which stabilizes gate and source potentials of the driving transistor, and a fourth switching transistor which switches between conduction and non-conduction between the source of the driving transistor and the third capacitive element. The circuit configuration of the current control unit, the disposition of the control line, the scanning line, and the signal line in the pixels grouped into driving blocks enable the threshold voltage of the driving transistors in the same driving block to be corrected in the same period and at the same timing. Accordingly the load on the driving circuit which outputs a signal controlling a current path to control a signal voltage is reduced. Furthermore, the grouping into driving blocks and the two signal lines disposed in each pixel column enable a large part of one frame time T_f during which all pixels are refreshed to be allocated to the threshold voltage correction period for the driving transistors. Consequently, a driving current based on a signal voltage accurately corrected flows into the luminescence elements, thereby improving display quality. Moreover, the disposition of the fourth switching transistor enables the third capacitive element to hold a voltage corresponding to an accurate signal voltage.

[0084] Furthermore, in a display device according to an aspect of the present invention, the current control unit may include: a driving transistor that includes a gate, a source, and a drain, one of the source and the drain being connected to the

first power source line, the other of the source and the drain being connected to the other of the terminals of the luminescence element, and the driving transistor converting the signal voltage applied between the gate and the source of the driving transistor into the signal current; a fifth capacitive element that includes terminals, one of the terminals being connected to the gate of the driving transistor; a fifth switching transistor that includes a gate connected to the scanning line, one of a source and a drain connected to the one of the terminals of the fifth capacitive element, and the other of the source and drain connected to a reference power source line; and a sixth switching transistor that includes a gate connected to the first control line, one of a source and a drain connected to the other of the terminals of the fifth capacitive element, and the other of the source and drain connected to the source of the driving transistor, the one of the source and the drain of the first switching transistor may be connected to the other of the terminals of the fifth capacitive element, and the other of the source and the drain of the first switching transistor may be connected to the first signal line, and the one of the source and the drain of the second switching transistor may be connected to the other of the terminals of the fifth capacitive element, and the other of the source and the drain of the second switching transistor may be connected to the second signal line.

[0085] According to this aspect, the current control unit includes a driving transistor which converts a signal voltage to a signal current, a fifth capacitive element which holds voltages corresponding to a signal voltage and a standard voltage, a fifth switching transistor for providing a reference potential to the gate of the driving transistor, and a sixth switching transistor which switches between conduction and non-conduction between the source of the driving transistor and the fifth capacitive element. The circuit configuration of the current control unit, the disposition of the control line, the scanning line, and the signal line in the pixels grouped into driving blocks enable the threshold voltage of the driving transistors in the same driving block to be initialized in the same period and at the same timing. Accordingly the load on the driving circuit which outputs a signal controlling a current path to control a signal voltage is reduced. Furthermore, the grouping into driving blocks and the two signal lines disposed in each pixel column enable a large part of one frame time T_f during which all pixels are refreshed to be allocated to the period for resetting the driving transistors. Consequently, a driving current based on a signal voltage accurately corrected flows into the luminescence elements, thereby improving display quality. Moreover, the disposition of the sixth switching transistor enables the fifth capacitive element to hold a voltage corresponding to an accurate signal voltage.

[0086] Furthermore, in a display device according to an aspect of the present invention, the first power source line may be disposed in each of the rows, and applies a first voltage and a second voltage, the first voltage being a voltage lower than the standard voltage, and the second voltage being a voltage higher than the standard voltage, the current control unit may include: a driving transistor that includes a gate, a source, and a drain, one of the source and the drain being connected to the other of the terminals of the luminescence element, the other of the source and the drain being connected to the first power source line, and the driving transistor converting the signal voltage applied between the gate and the source of the driving transistor into the signal current which is a drain current of the driving transistor; a sixth capacitive element that includes terminals, one of the terminals being connected to the gate of

the driving transistor, the other of the terminals being connected to the one of the source and the drain of the driving transistor, the sixth capacitive element holding at least a voltage corresponding to the signal voltage or the standard voltage, the other of the source and the drain of the first switching transistor may be connected to the gate of the driving transistor, the other of the source and the drain of the second switching transistor may be connected to the gate of the driving transistor, the display device may further include a control unit configured to control application of the first voltage and the second voltage in at least one of the threshold voltage detection period and the initializing period with a first timing which is the same for the pixels in the same one of the driving blocks, and control the application of the first voltage and the second voltage with a second timing different from the first timing for the pixels in different ones of the driving blocks.

[0087] According to this aspect, the current control unit includes a driving transistor which converts a signal voltage to a signal current and a sixth capacitive element which holds voltages corresponding to a signal voltage and a standard voltage. The circuit configuration of the current control unit, and the disposition of the control line, the scanning line, the signal line, and the power source line in the pixels grouped into driving blocks enable the threshold voltage of the driving transistors in the same driving block to be corrected in the same period and at the same timing. Accordingly the load on the driving circuit which outputs a signal controlling a current path to control a signal voltage is reduced. Furthermore, the grouping into driving blocks and the two signal lines disposed in each pixel column enable a large part of one frame time T_f during which all pixels are refreshed to be allocated to the threshold voltage correction period for the driving transistors. Consequently, a driving current based on a signal voltage accurately corrected flows into the luminescence elements, thereby improving display quality.

[0088] Furthermore, in a display device according to an aspect of the present invention, the luminescence element may be an electroluminescence (EL) element that produces the luminescence according to the signal voltage.

[0089] According to this aspect, grouping into driving blocks and disposition of the selector circuit in an active matrix organic EL display panel enable large parts of one frame time to be allocated to the initialization period and the threshold voltage correction period. Accordingly, the output load on the driving circuit and cost of the driving circuit can be reduced and the manufacturing yield can be improved.

[0090] Furthermore, the present invention can be implemented, not only as a display device including such characteristic units, but also as a display device controlling method having, as steps, the characteristic units included in the display device.

First Embodiment

[0091] A first embodiment of the present invention shall be described below with reference to the Drawings.

[0092] FIG. 1 is a block diagram showing the electrical configuration of a display device according to a first embodiment of the present invention. A display device 1 in the figure is a display device including pixels arranged in rows and columns, and includes a display panel 10 and a control circuit 20. The display panel 10 includes plural pixels 11A and 11B, a signal line group 12, a control line group 13, a scanning/control line driving circuit 14, a signal line driving circuit 15, and a selector circuit 16.

[0093] The pixels 11A and 11B are arranged in rows and columns on the display panel 10. Here, the pixels 11A and 11B compose two or more driving blocks each of which is one driving block made up of plural pixel rows. Specifically, the pixels 11A compose a k -th driving block (k is a positive integer) and the pixels 11B compose a $(k+1)$ -th driving block. This means that, for example, the pixels 11A compose odd driving blocks and the pixels 11B compose even driving blocks. However, in the case where the display panel 10 is divided into N driving blocks, $(k+1)$ is a positive integer equal to or less than N .

[0094] The signal line group 12 includes plural signal lines disposed in each of the pixel columns. Here, two signal lines (first signal line 151 and second signal line 152) are disposed in each of the pixel columns, the pixels of odd driving blocks are connected to a first signal line, and the pixels of even driving blocks are connected to a second signal line different from the first signal line. In this manner, the two signal lines (first signal line 151 and second signal line 152) are disposed in each of the pixel columns, and are for applying, to the corresponding pixels 11A and 11B, the standard voltage for detecting the threshold voltage of the driving transistor and for initializing the driving transistor and the signal voltage for determining the luminance intensity of the pixels.

[0095] The set of control lines 13 is made up of scanning lines and control lines, each disposed in each pixel.

[0096] The scanning/control line driving circuit 14 outputs a scanning signal to each of the scanning lines in the set of control lines 13 and a control signal to each of the control lines in the set of control lines 13 to drive a circuit element of each pixel.

[0097] The signal line driving circuit 15 selectively outputs a standard voltage and a signal voltage that determines the luminance of the pixels onto an output line provided in each pixel column. Specifically, the signal line driving circuit 15 outputs a signal voltage that determines the luminance of the pixels to each signal line in the signal line group 12 through the selector circuit 16 to drive the circuit elements of the pixels.

[0098] The selector circuit 16 has the function of mutually exclusively providing a signal voltage and a standard voltage to a selected one of the first signal line 151 and the second signal line 152. Specifically, the selector circuit 16 controls selectors which are provided for each pixel column and selectively provide a standard voltage or a signal voltage outputted from an output line to one of the first signal line and the second signal line. Details will be described later and therefore further description of the selector circuit 16 will be omitted here.

[0099] The control circuit 20 controls the timings of output and voltage levels of a scanning signal and a control signal outputted from the scanning/control line driving circuit 14. The control circuit 20 also controls the timing of output of a signal voltage or a standard voltage outputted from the signal line driving circuit 15.

[0100] The control circuit 20 also functions as a selector control unit which controls a signal line selecting operation of the selector circuit 16 with the control signal outputted from the scanning/control line driving circuit 14, so that the signal voltage and the standard voltage are mutually exclusively provided onto the first signal line and the second signal line.

[0101] The control circuit 20, the scanning/control line driving circuit 14 and the signal line driving circuit 15 constitute a control unit which controls operations of the pixels.

The control circuit **20** causes at least one of threshold detection in which a standard voltage is applied to each pixel to detect a threshold voltage of the pixel circuit and initialization of each pixel circuit to occur in all the pixels in the same driving block in the same period and causes at least one of threshold detection and initialization that occurs in the same driving block in the same period to occur in different driving blocks in different periods. Here, causing at least one of the threshold detection and the initialization to occur in the same driving block in the same period means that the threshold detection or the initialization is caused to start and end in the pixels in the same driving block at the same start time and the same end time; causing at least one of the threshold detection and the initialization that occur in the same driving block in the same period to occur in different blocks in different periods means that the threshold detection or the initialization in the pixels in different blocks is caused to start and end at different start times and different end times and the threshold detection period and the initialization period are prevented from overlapping each other.

[0102] FIG. 2A is a circuit diagram specifically illustrating a pixel in an odd-numbered driving block in a display device according to the first embodiment of the present invention. FIG. 2B is a circuit diagram specifically illustrating a pixel in an even-numbered driving block in the display device according to the first embodiment of the present invention. Each of the pixels **11A** and **11B** depicted in FIGS. 2A and 2B includes an organic Electro Luminescence (EL) element **113**, a driving transistor **114**, switching transistors **115** and **116**, holding capacitors **117** and **118**, a second control line **131**, a first control line **132**, a scanning line **133**, a first signal line **151**, and a second signal line **152**. Here, the driving transistor **114**, the switching transistor **116**, and the holding capacitors **117** and **118** make up a current control unit **100**.

[0103] The current control unit **100** is connected to a first power source line (power source line **112**), the other terminal of a luminescence element (organic EL element **113**), and the first control line and converts a signal voltage to a signal current. Specifically, the current control unit **100** is connected to a power source line **110**, which is a first power source line, an anode of the organic EL element **113**, the second control line **131**, the first control line **132**, and one of source and drain terminals of the switching transistor **115**. This configuration allows the current control unit **100** to have the function of converting a signal voltage provided through the first signal line **151** or the second signal line **152** to a signal current, which is a source-drain current of the driving transistor **114**.

[0104] The organic EL element **113** has one terminal connected to a second power source line and produces luminescence when a signal current corresponding to a signal voltage flows through the organic EL element **113**. Specifically, the organic EL element **113** is a luminescence element having a cathode connected to the power source line **112**, which is a second power source line, and an anode connected to the source of the driving transistor **114**, and produces luminescence when a driving current of the driving transistor **114** flows through the organic EL element **113**.

[0105] The driving transistor **114** is included in the current control unit in the present invention. The driving transistor **114**, one of a source and drain of which is connected to the other end of the luminescence element, converts the signal voltage applied between the gate and source to the signal current, which is a drain current. Specifically, when a voltage corresponding to a signal voltage is applied between the gate

and source, the driving transistor **114** converts a source-drain current corresponding to the voltage. The source-drain current is provided to the organic EL element **113** as a driving current. The driving transistor **114** is implemented by an n-type thin-film transistor (n-type TFT), for example.

[0106] The switching transistor **115** is a third switching transistor having a gate electrode connected to the scanning line **133**. One of a source and a drain of the switching transistor **115** is connected to the first signal line **151** and the other of the source and drain is connected to the current control unit. The switching transistor **115** switches between conduction and non-conduction between the first signal line **151** and the current control unit. Specifically, the gate is connected to the scanning line **133** and one of the source and the drain is connected to the gate of the driving transistor **114**. In the pixels **11A** in an odd-numbered driving block, the other of the source and the drain is connected to the first signal line **151** so that the switching transistor **115** functions as a first switching transistor; in the pixels **11B** in an even-numbered driving block, the other of the source and the drain is connected to the second signal line **152** so that the switching transistor **115** functions as a second switching transistor.

[0107] The switching transistor **116** is a third switching transistor having a gate connected to the second control line **131**. One of a source and a drain of the switching transistor **116** is connected to the power source line **110**, which is a positive power source line. The switching transistor **116** has the function of turning on and off the drain current of the driving transistor **114**.

[0108] It should be noted that the source and the drain of the switching transistor **116** are preferably connected between the power source line **110** and the anode of the organic EL element. This arrangement enables the source-drain current of the driving transistor **114** to be turned on and off. The switching transistors **115** and **116** are implemented by n-type thin-film transistors (n-type TFTs), for example.

[0109] The holding capacitor **117** is a first capacitive element that has one terminal connected to the gate of the driving transistor **114** and another terminal connected to the source of the driving transistor **114**. The holding capacitor **117** has the function of holding a charge corresponding to a signal voltage provided through the first signal line **151** or the second signal line **152** and controlling a signal current provided from the driving transistor **114** to the organic EL element **113** for example after the switching transistor **115** turns off.

[0110] The holding capacitor **118** is a second capacitive element connected between the other terminal of the holding capacitor **117** and the first control line **132**. In a steady state, the holding capacitor **118** first holds a source potential of the driving transistor **114** and information on the source potential remains at a node between the holding capacitor **117** and the holding capacitor **118** even when a signal voltage is applied from the switching transistor **115**. It should be noted that the source potential at this point in time is a threshold voltage of the driving transistor **114**. When subsequently the timing between the holding of the signal voltage and production of luminescence varies among pixel rows, a gate voltage of the driving transistor **114** is fixed because the potential at the other terminal of the holding capacitor **117** is fixed. On the other hand, a source potential of the driving transistor **114** is already in the steady state. Accordingly, the holding capacitor **118** has the function of holding the source potential of the driving transistor **114**.

[0111] The second control line 131 is disposed in each pixel row and is shared by all the pixels in the same driving block, but is independent among the different driving blocks. Here, the second control line 131 is shared by all the pixels in the same driving block means that one control signal outputted from the scanning/control line driving circuit 14 is provided onto the second control lines 131 in the same driving block at the same time. For example, in the same driving block, one control line connected to the scanning/control line driving circuit 14 branches into second control lines 131 each being disposed in each pixel row. That the second control line 131 is independent among different driving blocks means that individual control signals outputted from the scanning/control line driving circuit 14 are provided to a plurality of driving blocks. For example, the second control line 131 in each driving block is connected to the scanning/control line driving circuit 14 separately from the other second control lines 131. Specifically, the second control line 131 is connected to the scanning/control line driving circuit 14 and to the pixels that belong to pixel rows that include the pixels 11A and 11B. Thus, the second control line 131 has the function of providing timings of turning on and off the source-drain current of the driving transistor 114.

[0112] The first control line 132 is disposed in each pixel row and is shared by all pixels in the same driving block, but is independent among the different driving blocks. Specifically, the first control line 132 is connected to the scanning/control line driving circuit 14 and to each of the pixels that belong to the pixel rows including the pixels 11A and 11B. This allows the first control line 132 to have the function of preparing conditions for detecting the threshold voltage of the driving transistor 114 by a voltage level change.

[0113] The scanning line 133 has the function of providing timing of storing a signal voltage or a standard voltage for detecting the threshold voltage of the driving transistor 114 in the pixels that belong to the pixel rows including the pixels 11A and 11B.

[0114] The first signal line 151 and the second signal line 152 are connected to the selector circuit 16 and to each of the pixels that belong to the pixel rows including the pixels 11A and 11B, respectively, and have the function of providing a standard voltage for detecting the threshold voltage of the driving transistor 114 and a signal voltage that determines luminance.

[0115] It should be noted that while not depicted in FIGS. 2A and 2B, the power source line 110 and the power source line 112 each are also connected to other pixels and to voltage sources.

[0116] A circuit configuration and function of the selector circuit 16 will be described below in detail. FIG. 3 is a circuit diagram of a selector circuit of the display device according to an embodiment of the present invention and its neighboring circuitry.

[0117] The selector circuit 16 includes selecting transistors 161 and 162, which are selectors disposed for each pixel column. In the selector circuit 16, the selecting transistor 161 or the selecting transistor 162 is controlled to selectively provide a standard voltage or a signal voltage outputted to an output line of a data driver 150 of the signal line driving circuit 15 to one of the first signal line 151 and the second signal line 152. Specifically, a first selector control line 141 is used to control the selecting transistors 161 and a second selector control line 142 is used to control the selecting transistors 162.

[0118] The signal line driving circuit 15 includes data drivers 150, each provided for each pixel column. The data drivers 150 are ICs which output a signal voltage corresponding to an input signal from the control circuit 20 to pixel columns connected to the data drivers 150.

[0119] The selecting transistor 161 is equivalent to a selector in the present invention. One of a source and a drain of the selecting transistor 161 is connected to the first signal line 151 and the other of the source and the drain is connected to the output line of the data driver 150. A gate of the selecting transistor 161 is connected to the first selector control line 141. The gate of the selecting transistor 161 is turned on and off through the first selector control line 141 to cause the selecting transistor 161 to selectively provide a standard voltage or a signal voltage outputted from the data driver 150 to the first signal line 151. For example, when the voltage level of the first selector control line 141 is HIGH, the selecting transistor 161 turns on to provide the signal voltage or the standard voltage provided from the data driver 150 to the first signal line 151. When the voltage level of the first selector control line 141 is LOW, for example, the selecting transistor 161 turns off to disconnect itself from the output line of the data driver 150.

[0120] Similarly, the selecting transistor 162 is equivalent to a selector in the present invention. One of a source and a drain of the selecting transistor 162 is connected to the second signal line 152 and the other of the source and drain is connected to the output line of the data driver 150. A gate of the selecting transistor 162 is connected to the second selector control line 142. The gate of the selecting transistor 162 is turned on and off through the second selector control line 142 to cause the selecting transistor 162 to selectively provide a standard voltage or a signal voltage outputted from the data driver 150 to the second signal line 152. For example, when the voltage level of the second selector control line 142 is HIGH, the selecting transistor 162 turns on to provide the signal voltage or the standard voltage provided from the data driver 150 to the second signal line 152. When the voltage level of the second selector control line 142 is LOW, for example, the selecting transistor 162 turns off to disconnect itself from the output line of the data driver 150.

[0121] The first selector control line 141 and the second selector control line 142 are connected to the scanning/control line driving circuit 14 as illustrated in FIG. 3, for example, and have the function of providing timings of turning on and off a source-drain current of the selecting transistors 161 and the selecting transistors 162. Specifically, voltage levels (for example, HIGH and LOW) of the first selector control line 141 and the second selector control line 142 are mutually exclusively controlled. This enables the standard voltage or the signal voltage outputted to the output line of each data driver 150 to be selectively provided to one of the first signal line 151 and the second signal line 152.

[0122] It should be noted that in a conventional signal line driving circuit, as many data driver ICs and output lines as the number of signal lines needed to be disposed and signal voltages of the signal lines needed to be independently driven. According to the present embodiment, only one output line of the signal line driving circuit 15 is provided for the two signal lines disposed for each pixel column because the selector circuit 16 is disposed between the signal line driving circuit 15 and the signal line group 12. Thus, the size of the signal line driving circuit 15 can be reduced and, thanks to the reduction of the numbers of data drivers 150 and output lines,

the cost for mounting the driving circuit can be reduced and the manufacturing yield can be improved.

[0123] The first selector control line 141 and the second selector control line 142 do not necessarily need to be connected to the scanning/control line driving circuit 14 and may be directly connected to the control circuit 20, for example, provided that the first and second selector control lines 141 and 142 have the function described above.

[0124] Connections of the second control lines 131, the first control lines 132, the scanning lines 133, the first signal lines 151, and the second signal lines 152 among the pixels will be described below.

[0125] FIG. 4 is a circuit diagram illustrating a portion of the display panel of the display device according to the first embodiment of the present invention. FIG. 4 illustrates two adjacent driving blocks, control lines, scanning lines, and signal lines. The control lines, the scanning lines, and the signal lines are denoted by a reference numeral followed by (block number, row number in the block) or a reference numeral followed by (block number) in the figure and the following description.

[0126] As described earlier, a driving block is made up of a plurality of pixel rows and two or more driving blocks exist in the display panel 10. For example, each of the driving blocks depicted in FIG. 4 is made up of m pixel rows.

[0127] In the k -th driving block depicted in the upper part of FIG. 4, a second control line 131 (k) is connected to the gate of the switching transistor 116 of every pixel 11A in the driving block in common. A first control line 132 (k) is connected to the holding capacitor 118 of every pixel 11A in the driving block in common. On the other hand, scanning lines 133 ($k, 1$) to 133 (k, m) are connected individually to pixel rows. Connections similar to those in the k -th driving block are made in the ($k+1$)-th driving block depicted in the lower part of FIG. 4. However, the second control line 131 (k) connected to the k -th driving block and the second control line 131 ($k+1$) connected to the ($k+1$)-th driving block are different from each other and individual control signals are outputted from the scanning/control line driving circuit 14 to the second control lines 131 (k) and 131 ($k+1$). Furthermore, the first control line 132 (k) connected to the k -th driving block and the first control line 132 ($k+1$) connected to the ($k+1$)-th driving block are different from each other and individual control signals are outputted from the scanning/control line driving circuit 14 to the first control lines 132 (k) and 132 ($k+1$).

[0128] In the k -th driving block, the first signal line 151 is connected to one of the source and drain of the switching transistor 115 of every pixel 11A in the driving block. In the ($k+1$)-th driving block, on the other hand, the second signal line 152 is connected to one of the source and drain of the switching transistor 115 of every pixel 11B in the driving block.

[0129] Grouping into driving blocks as described above reduces the number of second control lines 131 for controlling on and off of application of a voltage to the drains of the driving transistors 114.

[0130] The grouping into driving blocks also reduces the number of the first control lines 132 for controlling V_{th} detection circuits which detect the threshold voltage V_{th} of the driving transistors 114. Accordingly, the number of outputs of the scanning/control line driving circuit 14 which outputs a driving signal onto the control lines is reduced and therefore the circuit size can be reduced.

[0131] A method for controlling the display device 1 according to this embodiment will now be described with reference to FIG. 5. Here, a control method for the display device having the specific circuit configuration depicted in FIGS. 2A and 2B will be described in detail.

[0132] FIG. 5 is a timing chart of an operation of a method for driving the display device according to the first embodiment of the present invention. The horizontal axis of the timing chart represents time. Shown in the timing chart in rows are, in order from top, waveforms of voltages appearing on the scanning lines 133 ($k, 1$), 133 ($k, 2$), and 133 (k, m), the first signal line 151, the second control line 131 (k), and the first control line 132 (k) in the K -th driving block. Following these are waveforms of voltages appearing on the scanning lines 133 ($k+1, 1$), 133 ($k+1, 2$), and 133 ($k+1, m$), the second signal line 152, the second control line 131 ($k+1$), and the first control line 132 ($k+1$) in the ($k+1$)-th driving block. FIG. 6 is a state transition diagram of a pixel of the display device according to the first embodiment of the present invention. FIG. 7 is a flowchart of an operation of the display device according to the first embodiment of the present invention.

[0133] First, immediately before time t_0 , the voltage levels of the scanning lines 133 ($k, 1$) to 133 (k, m) are all LOW and the voltage levels of the first control line 132 (k) and the second control line 131 (k) are also LOW. At the instant when the second control line 131 (k) is forced to LOW, the switching transistors 116 turn off as illustrated in FIG. 6(a). This optically quenches the organic EL elements 113 and simultaneous production of luminescence in the pixels in the k -th driving block ends and a non-luminescence-production period in the k -th driving block starts.

[0134] Then, at time t_0 , the scanning/control line driving circuit 14 changes the voltage levels of the scanning lines 133 ($k, 1$) to 133 (k, m) from LOW to HIGH at the same time to turn on the switching transistors 115. At this point in time, the second control line 131 (k) has already become LOW to turn off the switching transistor 116 (S11 of FIG. 7).

[0135] At this point in time, the voltage level of the first signal line 151 has changed from a signal voltage to a standard voltage to turn off the driving transistor 114 (S12 of FIG. 7).

[0136] Specifically, the first signal line 151 is provided with the signal voltage from the signal line driving circuit 15 through the selector circuit 16 before time t_0 and provided with the standard voltage through the selector circuit 16 for a predetermined period of time from time t_0 . Then, the first signal line 151 is disconnected from the signal line driving circuit 15 by the selector circuit 16 but a parasitic capacitance of the first signal line 151 holds the standard voltage. Thus, the first signal line 151 holds the standard voltage until the first signal line 151 is subsequently connected to the signal line driving circuit 15 through the selector circuit 16 and provided with a signal voltage. It should be noted that the signal line driving circuit 15 is outputting the standard voltage to the first signal line 151 through the selector circuit 16 for a certain period of time from time t_0 , then, outputs the signal voltage to the second signal line 152 through the selector circuit 16.

[0137] Here, a method for using the selector circuit 16 to change a voltage of the first signal line 151 from the standard voltage to the signal voltage will be described.

[0138] FIG. 8 is a timing chart of an operation for driving the selector circuit of the display device according to the first embodiment of the present invention.

[0139] The vertical axis of FIG. 8(a) schematically represents of rows of the display panel and the horizontal axis represents time. Slant lines in FIG. 8(a) represent signal voltages applied to four driving blocks, the k-th to k+3-th driving blocks, in sequence. Flat line segments represent periods in which the data driver 150 outputs the standard voltage and a signal voltage is not applied to any of the driving blocks.

[0140] The horizontal axis of FIG. 8(b) represents time. Shown in FIG. 8(b) in rows are, in order from top, waveforms of voltages appearing on scanning lines of the k-th to k+3-th driving blocks and waveforms of voltages appearing on the first signal line 151, the second signal line 152, the first selector control line 141, the second selector control line 142, and the data driver 150. The scanning lines of the four driving blocks shown in FIG. 8(b) are scanning lines 133 (k, 1), . . . , 133 (k, m) of the k-th driving block for driving circuit elements of pixels 11B, scanning lines 133 (k+1, 1), . . . , 133 (k+1, m) of the k+1-th driving block for driving circuit elements of pixels 11A, scanning lines 133 (k+2, 1), . . . , 133 (k+2, m) of the k+2-th driving block for driving circuit elements of pixels 11B, and scanning lines 133 (k+3, 1), . . . , 133 (k+3, m) of the k+3-th driving block for driving circuit elements of pixels 11A, for example.

[0141] FIG. 9A is a diagram for explaining a state in a certain period in which the standard voltage is being provided from the signal line driving circuit 15 to the first signal line 151. FIG. 9B is a diagram for explaining a state in which a signal voltage is being provided from the signal line driving circuit 15 to the second signal line 152. FIG. 9C is a diagram for explaining a state in a certain period in which the standard voltage is being provided from the signal line driving circuit 15 to the second signal line 152. FIG. 9D is a diagram for explaining a state in which a signal voltage is being provided from the signal line driving circuit 15 to the first signal line 151.

[0142] As illustrated in FIG. 8(b), the data driver 150 of the signal line driving circuit 15 mutually exclusively provides (outputs) a signal voltage and the standard voltage. The data driver 150 is providing the standard voltage only in certain periods indicated as period T1-1 and period T2-1, for example, in one frame period and is providing a signal voltage in other periods indicated as period T1-2 and period T2-2.

[0143] For example, in the period indicated as period T1-1, the voltage level of the first selector control line 141 is HIGH, the voltage level of the second selector control line 142 is LOW, and the standard voltage is being provided from the data driver 150 to the first signal line 151. At this time, the voltage level of the scanning lines 133 (k+2, 1) to 133 (k+2, m) in the k+2-th driving block corresponding to period T1-1 is simultaneously changed from LOW to HIGH by the scanning/control line driving circuit 140 to turn on the switching transistors 115.

[0144] Accordingly, the standard voltage is provided from the data driver 150 and is stored (SAMPLE) in the parasitic capacitance of the first signal line 151 in period T1-1 as illustrated in FIG. 9A.

[0145] Then, in the period illustrated as period T1-2, the voltage level of the first selector control line 141 is LOW and the voltage level of the second selector control line 142 is HIGH, therefore a signal voltage is being provided from the data driver 150 to the second signal line 152. During this period, organic EL elements 113 of the pixels 11A in the k+1-th driving block are producing luminescence.

[0146] Thus, in period T1-2, the signal voltage is being provided from the data driver 150 to the second signal line 152 as illustrated in FIG. 9B to cause the pixels that are connected to the second signal line 152 (here, all of the pixels 11A in the (k+1)-th driving block) to produce luminescence according to the signal voltage provided. On the other hand, the first signal line 151 is disconnected from the signal line driving circuit 15 but the parasitic capacitance of the first signal line 151 holds the standard voltage provided from the data driver 150 in period T1-1.

[0147] Then, in the period indicated as period T2-1, the voltage level of the first selector control line 141 is LOW, the voltage level of the second selector control line 142 is HIGH. The standard voltage is provided from the data driver 150 to the second signal line 152. At this time, the voltage level of the scanning lines 133 (k+3, 1) to 133 (k+3, m) in the k+3-th driving block corresponding to period T2-1 is simultaneously changed from LOW to HIGH by the scanning/control line driving circuit 140 to turn on the switching transistors 115.

[0148] Accordingly, the standard voltage is provided from the data driver 150 and is stored (SAMPLE) in the parasitic capacitance of the second signal line 152 in period T2-1 as illustrated in FIG. 9C.

[0149] Then, in the period illustrated as period T2-2, the voltage level of the first selector control line 141 is HIGH and the voltage level of the second selector control line 142 is LOW, therefore a signal voltage is being provided from the data driver 150 to the first signal line 151. During this period, organic EL elements 113 of the pixels 11B in the k+2-th driving block are producing luminescence.

[0150] Thus, in period T2-2, the signal voltage is being provided from the data driver 150 to the first signal line 151 as illustrated in FIG. 9D to cause the pixels that are connected to the first signal line 151 (here, all of the pixels 11B in the (k+2)-th driving block) to produce luminescence according to the signal voltage provided. On the other hand, the second signal line 152 is disconnected from the signal line driving circuit 15 but the parasitic capacitance of the second signal line 152 holds the standard voltage provided from the data driver 150 in period T2-1.

[0151] With this driving, the parasitic capacitances of the first signal line 151 and the second signal line 152 can be used to cause the first signal line 151 and the second signal line 152, respectively, to hold the standard voltage without needing dedicated standard signal lines for providing the standard signal voltage.

[0152] The description returns to the method for driving the display device 1 according to this embodiment.

[0153] At this point in time, that is, time t0 in FIG. 5, the standard voltage is provided from the data driver 150 to the first signal line 151 and is stored (SAMPLE) in the parasitic capacitance of the first signal line 151 as illustrated in FIG. 9A. The first signal line 151 holds the standard voltage until time t5a as illustrated in FIG. 9B. On the other hand, a signal voltage is being provided from the data driver 150 to the second signal line 152 until time t5 and the pixels that are connected to the second signal line 152 start producing luminescence according to the signal voltage provided. That is, period T1-1 and a portion of period T1-2 are included in the period from time t0 to time t1. Note that t5 and t8 can be the same time instants.

[0154] In this way, the standard voltage is held on the first signal line 151 and the standard signal voltage held on the first

signal line 151 is applied to the gate of the driving transistors 114 through the switching transistors 115 which are in the on state.

[0155] Then, at time t1, the scanning/control line driving circuit 14 changes the voltage level of the first control line 132 (k) from LOW to HIGH. After a predetermined time period has elapsed, at time t2, the scanning/control line driving circuit 14 changes the voltage level to LOW (S13 of FIG. 7). At this point in time, the voltage level of the control line 131 (k) is held LOW. Accordingly, the potential difference between the source electrode S (M) of the driving transistor 114 and the cathode electrode of the organic EL element 113 gradually approaches the threshold voltage of the organic EL element 113. It is assumed here that the standard signal voltage and the potential on the power source line 112 is 0 V, for example, the potential difference (VgH-VgL) between the HIGH voltage level (VgH) and LOW voltage level (VgL) of the first control line 132(k) is ΔV_{reset} , the capacitance value of the holding capacitor 118 is C_2 , and the capacitance and the threshold voltage of the organic EL element 113 are C_{EL} and $V_T(EL)$, respectively. Then, at the instant when the voltage level of the first control line 132 (k) is changed from LOW to HIGH, the potential V_s at the source electrode S (M) of the driving transistor 114 becomes approximately equal to the sum of the voltage divided by C_2 and C_{EL} plus $V_T(EL)$:

[Math. 1]

$$V_s \approx \frac{C_2}{C_2 + C_{EL}} \Delta V_{reset} + V_T(EL) \quad (\text{Formula 1})$$

Then, self-discharge of the organic EL element 113 occurs as illustrated in FIG. 6(b) and accordingly V_s gradually approaches $V_T(EL)$ in a steady state. That is, $V_s \rightarrow V_T(EL)$.

[0156] Then, at time t2, the scanning/control line driving circuit 14 changes the voltage level of the first control line 132 (k) from HIGH to LOW to bias V_s as:

[Math. 2]

$$V_s = V_T(EL) - \frac{C_2}{C_1 + C_2 + C_{EL}} \Delta V_{reset} < -V_{th} \quad (\text{Formula 2})$$

Here, ΔV_{reset} has been set such that the change of the voltage level of the first control line 132 (k) from HIGH to LOW causes a gate-source voltage V_{gs} higher than the threshold voltage V_{th} of the driving transistor 114 to appear between the gate and source of the driving transistor 114. That is, the potential difference appearing at the holding capacitor 117 is set at a value that enables the threshold voltage of the driving transistor 114 to be detected. Thus, preparation for a threshold voltage detection stage is completed.

[0157] Then, at time t3, the scanning/control line driving circuit 14 changes the voltage level of the second control line 131 (k) from LOW to HIGH to turn on the switching transistor 116. As a result, the driving transistor 114 turns on to allow a drain current to flow into the holding capacitors 117 and 118 and the organic EL element 113, which is in the off state, as illustrated in FIG. 6(c). Then, V_s defined by Formula 2 gradually approaches $-V_{th}$. As a result, the gate-source voltage of the driving transistor 114 is held in the holding capacitors 117 and 118 and the organic EL element 113. It should be noted

that at this point in time the potential at the anode electrode of the organic EL element 113, that is, the potential at the source electrode of the driving transistor 114, is lower than $-V_{th}$ (<0) and the potential at the cathode of the organic EL element 113 is 0 V, thus the organic EL element 113 is reverse biased. Therefore, the organic EL element 113 does not produce luminescence but functions as a capacitor C_{EL} .

[0158] In the period from time t3 to time t4, the circuit of the pixel 11A enters and stays in a steady state and a voltage equivalent to the threshold voltage V_{th} of the driving transistor 114 is held in the holding capacitors 117 and 118. Note that since current flowing to cause the holding capacitors 117 and 118 to hold the voltage equivalent to the threshold voltage V_{th} is small, it takes time for the circuit to be placed in the steady state. The longer the time period, the more stabilized the voltage held in the holding capacitor 117 becomes. By providing a sufficiently long time for this period, accurate voltage compensation can be achieved.

[0159] Then, at time t4, the scanning/control line driving circuit 14 changes the voltage level of the second control line 131 (k) from HIGH to LOW (S14 of FIG. 7). This discontinues the supply of current to the driving transistor 114. At this point in time, a voltage equivalent to the threshold voltage V_{th} of the driving transistors 114 is simultaneously held in the holding capacitors 117 and 118 of all pixels 11A in the k-th driving block.

[0160] Then, at time t5, the scanning/control line driving circuit 14 simultaneously changes the voltage level of the scanning lines 133 (k, 1) to 133 (k, m) from HIGH to LOW to turn off the switching transistor 115.

[0161] Thus, in the period from time t0 to time t5, the threshold voltage V_{th} of the driving transistors 114 in the k-th driving block is being simultaneously corrected. The period from time t0 to time t5 is equivalent to period T1-1 plus period T1-2 in FIG. 8 described above.

[0162] Then, in the period from time t5 to time t7, the scanning/control line driving circuit 14 changes the voltage level of the scanning lines 133 (k, 1) to 133 (k, m) from LOW to HIGH to LOW in sequence to turn on the switching transistors 115 in one pixel at a time in order of pixel row.

At this time, the voltage level of the first signal line 151 is changed from a standard voltage to a signal voltage V_{data} (S15 of FIG. 7).

[0163] Specifically, although the first signal line 151 is disconnected from the signal line driving circuit 15 before time t5 as described with reference to FIGS. 5A and 5B, the first signal line 151 is holding the standard voltage by the parasitic capacitance of the first signal line 151. After a certain period of time has elapsed (that is, after a certain period of time has elapsed from time t5), the first signal line 151 is connected to the signal line driving circuit 15 through the selector circuit 16 and provided with the signal voltage V_{data} . It should be noted that, at time t5, the signal line driving circuit 15 is outputting the standard voltage to the second signal line 152 through the selector circuit 16 as illustrated in FIG. 9C for a certain period of time and then outputs the signal voltage V_{data} to the first signal line 151 through the selector circuit 16.

[0164] As a result, the signal voltage V_{data} is applied to the gate of the driving transistor 114 as illustrated in FIG. 6(d). At this point in time, the potential V_M ($=V_s$) at a contact M between the holding capacitors 117 and 118 is equal to the amount of change ΔV_{data} of the signal voltage divided by C_1 and C_2 plus $-V_{th}$, which is V_s potential at time t4:

[Math. 3]

$$\begin{aligned}
 V_M &= \frac{C_1}{C_1 + C_2 + C_{EL}} \Delta V_{data} - V_{th} \\
 &= \frac{C_1}{C_1 + C_2 + C_{EL}} V_{data} - V_{th}
 \end{aligned}
 \tag{Formula 3}$$

[0165] Specifically, the potential difference V_{gs} held in the holding capacitor 117 is the difference between \bar{V}_{data} and the potential defined by Formula 3, as follows:

[Math. 4]

$$V_{gs} = \frac{C_2 + C_{EL}}{C_1 + C_2 + C_{EL}} V_{data} + V_{th}
 \tag{Formula 4}$$

[0166] That is, a sum voltage that is the sum of a voltage according to the signal voltage V_{data} and a voltage equivalent to the threshold voltage V_{th} of the driving transistor 114 held previously is held in the holding capacitor 117.

[0167] In this way, store of a corrected signal voltage is performed, one pixel row after another in the k-th driving block during the period from time t5 to time t7.

[0168] Then, after time t7, the voltage level of the second control line 131 (k) is changed from LOW to HIGH (S16 of FIG. 7). As a result, a driving current according to the sum voltage flows in the organic EL element 113. That is, luminescence production is started simultaneously in all the pixels 11A in the k-th driving block.

[0169] In this way, the organic EL elements 113 in the k-th driving block simultaneously produce luminescence after time t7. Here, the drain current i_d flowing through the driving transistor 114 can be expressed using a voltage value that is equal to V_{gs} defined by Formula 4 minus the threshold voltage V_{th} of the driving transistor 114 as follows:

[Math. 5]

$$i_d = \frac{\beta}{2} \left(\frac{C_2 + C_{EL}}{C_1 + C_2 + C_{EL}} V_{data} \right)
 \tag{Formula 5}$$

Here, β is a characteristic parameter relating to mobility. It can be seen from Formula 5 that the drain current i_d for causing the organic EL element 113 to produce luminescence is independent of the threshold voltage V_{th} of the driving transistor 114.

[0170] Since the pixel rows are grouped into driving blocks, the threshold voltages V_{th} of the driving transistors 114 in the same driving block are compensated for at the same time. The organic EL elements 113 in the same driving block also simultaneously produce luminescence. Accordingly, the driving currents of the driving transistors 114 in the same driving block can be turned on and off in synchronization and the current paths of the driving current from the sources onward can also be controlled in synchronization in the same driving block. Thus, the first control line 132 and the second control line 131 can be shared in the same driving block.

[0171] While the scanning lines 133 (k, 1) to 133 (k, m) are individually connected to the scanning/control line driving

circuit 14, these scanning lines are driven by a driving pulse at the same timing in the threshold voltage compensation period. Therefore, increase of the frequency of the pulse signal outputted from the scanning/control line driving circuit 14 can be minimized and output load on the driving circuit can be reduced accordingly. Furthermore, the provision of the selector circuit 16 can reduce the number of data drivers 150 and therefore the number of outputs from the control circuit 20.

[0172] On the other hand, it is difficult for the conventional display device 500 described in Japanese Unexamined Patent Application Publication No. 2008-122633 to accomplish the driving method that places only a low output load on the driving circuit described above. The pixel circuit illustrated in FIG. 32 compensates for a threshold voltage V_{th} of a driving transistor 512. However, after a voltage equivalent to the threshold voltage is held in a holding capacitor 513, the source potential at the driving transistor 512 varies and does not stabilize. Accordingly, in the display device 500, after the threshold voltage V_{th} is held, the sum voltage of the threshold voltage V_{th} plus a signal voltage needs to be immediately stored. Furthermore, a luminescence production operation needs to be performed immediately after the store because the sum voltage is also affected by source potential variations. That is, in the conventional display device 500, the threshold voltage compensation, the signal voltage store, and the luminescence production operation need to be performed in each pixel row and the pixels 501 as illustrated in FIG. 32 cannot be grouped into driving blocks.

[0173] In contrast, each of the pixels 11A and 11B of the display device 1 in the present invention has a switching transistor 116 attached to the drain of its driving transistor 114 as described above. Since this arrangement stabilizes the potentials at the gate and source of the driving transistor 114, the time from store of a voltage through threshold voltage correction to store of a signal voltage in addition to the voltage, or the time from the store of the signal voltage to luminescence production can be arbitrarily set for each pixel row. This circuit configuration enables grouping into driving blocks, which enables the threshold voltage correction in the same driving block to occur in the same period and luminescence production in the same driving block to occur in the same period.

[0174] Here, a duty cycle of luminescence production, which is defined by a threshold voltage detection period, of the display device with driving blocks according to the present invention will be compared with that of the conventional display device using two signal lines described in Japanese Unexamined Patent Application Publication No. 2008-122633.

[0175] FIG. 10 is a diagram illustrating waveform characteristics of a scanning line and a signal line. The threshold voltage V_{th} detection period in one horizontal period t_{1H} of each pixel row is equivalent to a period PW_S in which the scanning line is in the on state. One horizontal period t_{1H} for the signal line includes a signal voltage supply period PW_D and a standard voltage supply period t_D . One horizontal period t_{1H} can be expressed as:

[Math. 6]

[0176]

$$t_{1H} = t_D + PW_D + t_{R(D)} + t_{F(D)}
 \tag{Formula 6}$$

where $t_{R(S)}$ and $t_{F(S)}$ are the rise time and fall time of PW_S , respectively, and $t_{R(D)}$ and $t_{F(D)}$ of PW_D are the rise time and fall time of PW_D . Assume $PW_D = t_D$, then

[Math. 7]

[0177]

$$t_D + PW_D + t_{R(D)} + t_{F(D)} = 2(t_D + t_{R(D)} + t_{F(D)}) \quad (\text{Formula 7})$$

from Formulas 6 and 7,

[Math. 8]

[0178]

$$t_D = (t_{1H} - t_{R(D)} - t_{F(D)})/2 \quad (\text{Formula 8})$$

The V_{th} detection period needs to start and end within a standard voltage generation period. Assume that a maximum possible V_{th} detection time is ensured, then

[Math. 9]

[0179]

$$t_D = PW_S + t_{R(S)} + t_{F(S)} \quad (\text{Formula 9})$$

From Formulas 8 and 9,

[Math. 10]

[0180]

$$PW_S = (t_{1H} - t_{R(D)} - t_{F(D)} - 2t_{R(S)} - 2t_{F(S)})^2 \quad (\text{Formula 10})$$

is obtained.

[0181] Using Formula 10, the duty cycles of luminescence production of panels that have a vertical resolution of 1080 scanning lines (plus 30 blanking lines) and are driven with 120 Hz will be compared as an example.

[0182] Since one horizontal period t_{1H} of the conventional display device 500 using two signal lines is twice as long as one horizontal period of a display device using a single signal line,

$$t_{1H} = \{1 \text{ second} / (120 \text{ Hz} \times 1110 \text{ lines})\} \times 2 = 7.5 \mu\text{S} \times 2 = 15 \mu\text{S}$$

Here, substituting $t_{R(D)} = t_{F(D)} = 2 \mu\text{S}$ and $t_{R(S)} = t_{F(S)} = 1.5 \mu\text{S}$ in Formula 10 yields a V_{th} detection period PW_S of 2.5 μS .

[0183] Here, assuming that a V_{th} detection period required for providing a sufficiently high degree of accuracy is 1000 μS , then the horizontal periods required for the V_{th} detection are at least $1000 \mu\text{S} / 2.5 \mu\text{S} = 400$ as non-luminescence-production periods. Therefore, the luminescence production duty cycle of the conventional display device 500 using two signal lines is $(1110 \text{ horizontal periods} - 400 \text{ horizontal periods}) / 1110 \text{ horizontal periods} = \text{less than } 64\%$.

[0184] The luminescence production duty cycle of the display device using driving blocks according to the present invention will be determined next. Assuming that a V_{th} detection period of 1000 μS is required for ensuring a sufficient degree of accuracy as in the conditions described above, period A (threshold detection preparation period + threshold detection period) illustrated in FIG. 6A is equivalent to the 1000 μS period in the case of block driving. Since the non-luminescence-production period in 1 frame includes period A and the storing period, the non-luminescence-production period of one frame in this case is at least $1000 \mu\text{S} \times 2 = 2000 \mu\text{S}$. Therefore, the luminescence production duty cycle of the display device 1 using driving blocks according to the present

invention is $(1 \text{ frame time} - 2000 \mu\text{S}) / 1 \text{ frame time}$. Assigning $(1 \text{ second} / 120 \text{ Hz})$ to 1 frame time yields less than 76%.

[0185] The comparison given above shows that by combining block driving with the conventional display device that uses two signal lines as in the present invention can provide a longer luminescence production duty cycle when the same threshold detection period is set. Thus, a long-life display device with a sufficiently high luminance and a lower output load on the driving circuit can be implemented.

[0186] Conversely, it can be appreciated that when the same luminescence production duty cycle is set for the conventional display device that uses two signal lines and the display device that incorporates block driving according to the present invention, the display device in the present invention can provide a longer threshold detection period.

[0187] The description returns to the method for driving the display device 1 according to this embodiment.

[0188] At time t_8 , threshold voltage correction for the driving transistors 114 in the $(k+1)$ -th driving block starts.

[0189] Specifically, immediately before time t_8 , the voltage level of the scanning lines 133 ($k+1, 1$) to 133 ($k+1, m$) are all LOW and the voltage levels of the first control lines 132 ($k+1$) and the second control line 131 ($k+1$) are also LOW. Upon changing the voltage level of the second control line 131 ($k+1$) to LOW, the switching transistors 116 are turned off. As a result, the organic EL elements 113 are optically quenched and all the pixels in the $(k+1)$ -th driving block simultaneously discontinue producing luminescence and a non-luminescence-production period in the $(k+1)$ -th driving block starts.

[0190] Then, at time t_8 , which approximately coincides with time t_5 , the scanning/control line driving circuit 14 simultaneously changes the voltage level of the scanning lines 133 ($k+1, 1$) to 133 ($k+1, m$) from LOW to HIGH to turn on the switching transistors 115. At this point in time, the voltage level of the second control line 131 ($k+1$) is already LOW and the switching transistors 116 are in the off state (S21 of FIG. 7). Furthermore, at this point in time, the voltage level of the second signal line 152 has been changed from a signal voltage to a standard voltage (S22 of FIG. 7).

[0191] Specifically, the second signal line 152 is provided with the signal voltage from the signal line driving circuit 15 through the selector circuit 16 before time t_8 and is being provided with the standard voltage through the selector circuit 16 for a certain period of time from time t_8 . Then, the second signal line 152 is disconnected from the signal line driving circuit 15 by the selector circuit 16 but holds the standard voltage by the parasitic capacitance of the second signal line 152. Therefore, the second signal line 152 holds the standard voltage until the second signal line 152 is connected to the signal line driving circuit 15 through the selector circuit 16 and provided with a signal voltage. It should be noted that the signal line driving circuit 15 is outputting the standard voltage to the second signal line 152 through the selector circuit 16 for a certain period of time until time t_8 , and then outputs the signal voltage to the second signal line 152 through the selector circuit 16.

[0192] That is, at this time instant, the standard voltage is provided from the data driver 150 to the second signal line 152 and is stored (SAMPLE) in the parasitic capacitance of the second signal line 152 as illustrated in FIG. 9C. Then, the second signal line 152 holds the standard voltage until time t_9 as illustrated in FIG. 9D. On the other hand, a signal voltage is being provided from the data driver 150 to the first signal line 151 for the period of time until time t_9 and the pixels that

are connected to the first signal line 151 start producing luminescence according to the signal voltage provided.

[0193] In this way, the standard voltage is held on the second signal line 152, and the standard signal voltage held on the second signal line 152 is applied to the gate of the driving transistors 114 through the switching transistors 115 in the on state.

[0194] Then, at time t9, the scanning/control line driving circuit 14 changes the voltage level of the first control line 132 (k+1) from LOW to HIGH and, after a predetermined time period has elapsed, at time t10, changes the voltage level to LOW (S23 of FIG. 7). It should be noted that the voltage level of the second control line 131 (k+1) at this point in time is held LOW and therefore the potential difference between the source electrode S(M) of the driving transistor 114 and the cathode electrode of the organic EL element 113 starts to gradually approach the threshold voltage of the organic EL element 113. As a result, the potential difference held in the holding capacitor 117 in the current control unit 100 reaches a level that enables the threshold voltage of the driving transistor 114 to be detected. Thus, preparation for a threshold voltage detection stage is completed.

[0195] Then, at time t11, the scanning/control line driving circuit 14 changes the voltage level of the second control line 131 (k+1) from LOW to HIGH to turn on the switching transistor 116. As a result the driving transistor 114 turns on to allow a drain current to flow into the holding capacitors 117 and 118 and the organic EL element, which is in the off state. At this point in time, the gate-source voltage of the driving transistor 114 is held in the holding capacitors 117 and 118 and the organic EL element 113. It should be noted that at this point in time the potential at the anode electrode of the organic EL element 113, that is, the potential at the source electrode of the driving transistor, is lower than $-V_{th}$ (<0) and the potential at the cathode of the organic EL element 113 is 0V, thus the organic EL element 113 is reverse biased. Therefore, the organic EL element 113 does not produce luminescence but functions as a capacitor C_{EL} .

[0196] In the period from time t11 to time t12, the circuit of the pixel 11B enters and stays in a steady state and a voltage equivalent to the threshold voltage V_{th} of the driving transistor 114 is held in the holding capacitors 117 and 118. Note that the longer the time period, the more accurately the threshold voltage V_{th} held in the holding capacitors 117 and 118 is detected. By providing a sufficiently long time for this period, accurate voltage compensation can be achieved.

[0197] Then, at time t12, the scanning/control line driving circuit 14 simultaneously changes the voltage level of the scanning lines 133 (k+1, 1) to 133 (k+1, m) from HIGH to LOW to turn off the switching transistors 115 (S24 of FIG. 7). At this point in time, a voltage equivalent to the threshold voltage V_{th} of the driving transistors 114 is simultaneously held in the holding capacitors 117 of all pixels 11B in the (k+1)-th driving block.

[0198] Then, at time t13, the scanning/control line driving circuit 14 change the voltage level of the second control line 131 (k+1) from HIGH to LOW.

[0199] In this way, the threshold voltages V_{th} of the driving transistors 114 in the (k+1)-th driving block are simultaneously corrected in the period from time t11 to time t12.

[0200] Then, after time t13, the scanning/control line driving circuit 14 starts changing the voltage level of the scanning lines 133 (k+1, 1) to 133 (k+1, m) from LOW to HIGH to LOW in sequence to turn on the switching transistors 115 in

one pixel row a time in order of pixel row. At the same time, the second signal line 152 is changed from a standard voltage to a signal voltage (S25 of FIG. 7).

[0201] Specifically, although the second signal line 152 is disconnected from the signal line driving circuit 15 before time t13 as described with reference to FIGS. 9C and 9D, the second signal line 152 holds the standard voltage by the parasitic capacitance of the second signal line 152. Then, after a certain period of time has elapsed (that is, after a certain period of time has elapsed from time t13), the second signal line 152 is connected to the signal line driving circuit 15 through the selector circuit 16 and provided with a signal voltage V_{data} . It should be noted that at time t13, the signal line driving circuit 15 is outputting the standard voltage to the first signal line 151 through the selector circuit 16 as illustrated in FIG. 9A for a certain period of time, then outputs the signal voltage V_{data} to the second signal line 152 through the selector circuit 16.

[0202] As a result, the signal voltage is applied to the gates of the driving transistors 114. At this point in time, the sum voltage of a voltage according to the signal voltage V_{data} and a voltage equivalent to the threshold voltage V_{th} of the driving transistor 114 previously held is held in the holding capacitor 117.

[0203] Thus, after time t3, the corrected signal voltage is stored in the (k+1)-th driving block, one pixel row after another.

[0204] Then, after time t15, the voltage level of the second control line 131 (k+1) is changed from LOW to HIGH (S26 of FIG. 7). As a result, a driving current corresponding to the sum voltage described above flows in the organic EL elements 113. That is, all the pixels 11B in the (k+1)-th driving block simultaneously start producing luminescence.

[0205] In this way, the organic EL elements 113 in the (k+1)-th driving block simultaneously produce luminescence after time t15.

[0206] The operation described above is performed on the (k+2)-th driving block and subsequent driving blocks in the display panel 10 in sequence.

[0207] FIG. 11 is a state transition diagram of driving blocks that are producing luminescence according to the driving method of the first embodiment of the present invention. FIG. 11 illustrates luminescence production periods and non-luminescence-production periods of each driving block in a pixel column. The vertical axis represents a plurality of driving blocks and the horizontal axis represents elapsed time. Here, a non-luminescence-production period includes a threshold voltage correction period and a signal voltage storing period described above.

[0208] According to the method for controlling the display device according to the first embodiment of the present invention, a luminescence production period is set in the same driving block at the same time. Accordingly, the luminescence production periods appear stepwise from driving block to driving block with respect to a row scanning direction.

[0209] In this way, pixel circuits in each of which the switching transistor 116 and the holding capacitor 118 are disposed, the selector circuit disposed between the signal line driving circuit 15 and the signal line group 12, the disposition of the control lines, scanning lines and signal lines in the pixels grouped into driving blocks and in the selector circuit, and the control method described above enable the threshold voltage of the driving transistors 114 in the same driving block to be corrected in the same period and at the same

timing. Furthermore, a luminescence production period can be caused to occur in the same period and timing in the same driving block. Moreover, the provision of the selector circuit can reduce the number of outputs from the signal line driving circuit **15**. The reduction of the number of outputs reduces loads on the scanning/control line driving circuit **14** which outputs a signal controlling conduction and non-conduction of the switch elements and a signal controlling current paths, and loads on the signal line driving circuit **15** which controls a signal voltage, as well as the costs of the driving circuit, and improves panel manufacturing yield. Furthermore, grouping into driving blocks and the two signal lines disposed for each pixel columns enable a larger part of one frame time T_f in which all pixels are refreshed to be allocated to a threshold voltage correction period for the driving transistors **114**. This is because a threshold voltage correction period for the $(k+1)$ -th driving block is provided in a period during which a luminance signal is being sampled in the k -th driving block. Thus, the threshold voltage correction period is divided among the driving blocks, rather than being divided among the pixel rows. Accordingly, even the display area is increased, a long threshold voltage correction period can be set relative to one frame time without substantially increasing the number of outputs of the scanning/control line driving circuit **14** and without decreasing the luminescence production duty cycle. Consequently, a driving current based on an accurately corrected signal voltage flows into the luminescence elements, thereby improving display quality.

[0210] For example, if the display panel **10** is divided into N driving blocks, the threshold voltage correction period that is provided for each pixel is T_f/N at the maximum. In contrast, if threshold voltage correction periods are set at different timings for M different pixel rows ($M \gg N$), the threshold voltage correction period that is provided for each pixel is T_f/M at the maximum. If two signal lines as those described in Japanese Unexamined Patent Application Publication No. 2008-122633 are disposed for each pixel column, the threshold voltage correction period provided is $2T_f/M$ at the maximum.

[0211] Furthermore, grouping into driving blocks enables the second control line which controls on and off of application of a voltage to the drains of the driving transistors **114** and the first control line which controls a current path of the driving current from the sources onward can be shared in the same driving block. Accordingly, the number of control lines from the scanning/control line driving circuit **14** is reduced and therefore load on the driving circuit is reduced. For example, in the conventional display device **500** described in Japanese Unexamined Patent Application Publication No. 2008-122633, two control lines (a power supply line and a scanning line) are disposed for each pixel row. If the display device **500** includes M pixel rows, a total of $2M$ control lines are provided.

[0212] In contrast, in the display device **1** according to the first embodiment of the present invention, one scanning line per pixel row and two control lines per driving block are provided from the scanning/control line driving circuit **14**. Accordingly, if the display device **1** includes M pixel rows, a total of $(M+2N)$ control lines (including scanning lines) are provided.

[0213] When the display area is increased and the number of pixel rows increases accordingly, M will be much greater than N . In that case, the number of control lines of the display

device **1** according to the present invention can be reduced to about half the number of control lines of the conventional display device **500**.

Second Embodiment

[0214] A second embodiment of the present invention will now be described with reference to drawings.

[0215] FIG. **12** is a circuit diagram illustrating a portion of a display panel of a display device according to the second embodiment of the present invention. FIG. **12** illustrates two adjacent driving blocks, control lines, scanning lines, and signal lines. The control lines, the scanning lines, and the signal lines are denoted by a reference numeral followed by (block number, row number in the block) or a reference numeral followed by (block number) in the figure and the following description.

[0216] Each pixel of the display device illustrated in FIG. **12** has the same circuit configuration that of the display device **1** according to the first embodiment. The only difference from the display device **1** of the first embodiment is that a second control line **131** in the display device of the second embodiment is not communized in each driving block but a second control line **131** in each pixel row is connected to a scanning/control line driving circuit **14** (not shown). In the following description, the same elements as those of the display device **1** according to the first embodiment will be omitted and only differences from the first embodiment will be described.

[0217] In the k -th driving block illustrated in the upper part of FIG. **12**, second control lines **131** ($k, 1$) to **131** (k, m) are disposed in each pixel row in the driving block and are each individually connected to a gate of a switching transistor **116** of each pixel **11A**. A first control line **132** (k) is connected to holding capacitors **118** of all pixels **11A** in the driving block in common. On the other hand, scanning lines **133** ($k, 1$) to **133** (k, m) are each individually connected to each pixel row. In the $(k+1)$ -th driving block illustrated in the lower part of FIG. **12**, connections similar to those of the k -th driving block are made. However, a first control line **132** ($k+1$) connected to the $(k+1)$ -th driving block is a control line different from the first control line **132** (k) connected to the k -th driving block and individual control signals are outputted from a scanning/control line driving circuit **14**.

[0218] In the k -th driving block, a first signal line **151** is connected to one of a source or a drain of a switching transistor **115** of every pixel **11A** in the driving block. On the other hand, in the $(k+1)$ -th driving block, a second signal line **152** is connected to one of a source and a drain of a switching transistor **115** of every pixel **11B** in the driving block.

[0219] As described earlier, grouping into driving blocks reduces the number of first control lines **132** which control V_{th} detection circuits. Accordingly, load on the scanning/control line driving circuit **14** which outputs driving signals to the control lines is reduced.

[0220] Furthermore, in this embodiment, as in the embodiment in FIG. **1**, an output line of a signal line driving circuit **15** is connected to the first signal line **151** and the second signal line **152** through a selector circuit **16**.

[0221] A method for controlling the display device according to this embodiment will be described with reference to FIG. **13**.

[0222] FIG. **13** is a timing chart of an operation of a display device driving method according to the second embodiment of the present invention. The horizontal axis of the timing

chart represents time. Shown in FIG. 13 in rows are, in order from top, waveforms of voltages appearing on the scanning lines 133 ($k, 1$), 133 ($k, 2$), and 133 (k, m), a first signal line 151, the second control lines 131 ($k, 1$) and 131 (k, m), and the first control line 132 (k) in the k -th driving block. Following these are waveforms of voltages appearing on the scanning lines 133 ($k+1, 1$), 133 ($k+1, 2$), and 133 ($k+1, m$), the second signal line 152, the second control lines 131 ($k+1, 1$) and 131 ($k+1, m$), and the first control line 132 ($k+1$) in the ($k+1$)-th driving block.

[0223] The driving method according to this embodiment differs from the driving method according to the first embodiment illustrated in FIG. 5 only in that a signal voltage storing period and a luminescence production period are set for each pixel row, rather than causing luminescence production in the same period in the same driving block.

[0224] First, immediately before time t_{20} , the voltage level of all of the scanning lines 133 ($k, 1$) to 133 (k, m) are LOW and the voltage level of the first control line 132 (k) and the second control lines 131 ($k, 1$) to 131 (k, m) are also LOW. As illustrated in FIG. 6(a), upon changing the voltage level of the second control lines 131 ($k, 1$) to 131 (k, m) to LOW, the switching transistor 116 turns off. As a result, organic EL elements 113 are optically quenched and the pixels in each pixel row in the k -th driving block simultaneously discontinue producing luminescence. At the same time, a non-luminescence-production period in the k -th driving block starts.

[0225] Then, at time t_{20} , the scanning/control line driving circuit 14 simultaneously changes the voltage level of the scanning lines 133 ($k, 1$) to 133 (k, m) from LOW to HIGH to turn on the switching transistors 115. At this point in time, the second control lines 131 ($k, 1$) to 131 (k, m) are already LOW to turn off switching transistors 116 (S11 of FIG. 7). Also at this point in time, the voltage level of a first signal line 151 is changed from a signal voltage to a standard voltage (S12 of FIG. 7).

[0226] Here, the timing chart of an operation for driving the selector circuit according to this embodiment is the same as the timing chart of the operation described in the first embodiment and shown in FIG. 8. That is, at time t_{20} in FIG. 13, the standard voltage is provided from the data driver 150 to the first signal line 151 and is stored (SAMPLE) in the parasitic capacitance of the first signal line 151 as illustrated in FIG. 9A. The first signal line 151 holds the standard voltage as illustrated in FIG. 9B until time t_{25a} . On the other hand, a signal voltage is being provided from the data driver 150 to the second signal line 152 until time t_{25} and the pixels that are connected to the second signal line 152 start producing luminescence according to the signal voltage provided. That is, period T1-1 and a portion of period T-2 are included in the period from time t_{20} to time t_{21} . Note that t_{25} and t_{28} can be the same time instant.

[0227] In this way, the standard signal voltage is held on the signal line 151 and the standard voltage held on the first signal line 151 is applied to the gate of the driving transistors 114 through the switching transistors 115 in the on state.

[0228] Then, at time t_{21} , the scanning/control line driving circuit 14 changes the voltage level of the first control line 132 (k) from LOW to HIGH and, after a predetermined time period has elapsed, at time t_{22} , changes the voltage level to LOW (S13 of FIG. 7). The voltage level of the second control lines 131 ($k, 1$) to 131 (k, m) is held LOW at this point in time and therefore the potential difference between the source electrode S(M) of the driving transistor 114 and the cathode

electrode of the organic EL element 113 gradually approaches the threshold voltage of the organic EL element 113. The potential V_s at the source electrode S (M) of the driving transistor 114 at time t_{22} is defined by Formula 2 given in the first embodiment. As a result, the potential difference appearing at the holding capacitor 117 in the current control unit 100 reaches a level that enables the threshold voltage of the driving transistor to be detected. Thus, preparation for a threshold voltage detection stage is completed.

[0229] Then, at time t_{23} , the scanning/control line driving circuit 14 simultaneously changes the voltage level of the second control lines 131 ($k, 1$) to 131 (k, m) from LOW to HIGH to turn on the switching transistors 116. As a result, the driving transistor 114 turns on to allow a drain current to flow into the holding capacitors 117 and 118 and the organic EL element 113, which is in the off state. At this point in time, the V_s defined by Formula 2 starts to gradually approach $-V_{th}$. As a result, the gate-source voltage of the driving transistor 114 is held in the holding capacitors 117 and 118 and the organic EL element 113. It should be noted that at this point in time the potential at the anode electrode of the organic EL element 113, that is, the potential at the source electrode of the driving transistor, is lower than $-V_{th}$ (<0) and the potential at the cathode of the organic EL element 113 is 0V, thus the organic EL element 113 is reverse biased. Therefore, the organic EL element 113 does not produce luminescence but functions as a capacitor C_{EL} .

[0230] In the period from time t_{23} to time t_{24} , the circuits of the pixels 11A are placed in a steady state and a voltage equivalent to the threshold voltage V_{th} of the driving transistors 114 is held in the holding capacitors 117 and 118. It should be noted that since current flowing to cause the holding capacitors 117 and 118 to hold the voltage equivalent to the threshold voltage V_{th} is small, it takes time for the circuits to be placed in the steady state. The longer the time, the more stabilized the voltage held in the holding capacitor 117 and 118 becomes. By providing a sufficiently long time for this period, accurate voltage compensation can be achieved.

[0231] Then, at time t_{24} , the scanning/control line driving circuit 14 simultaneously changes the voltage level of the second control lines 131 ($k, 1$) to 131 (k, m) from HIGH to LOW (S14 of FIG. 7). This discontinues the supply of current to the driving transistors 114. At this point in time, a voltage equivalent to the threshold voltage V_{th} of the driving transistors 114 is simultaneously held in the holding capacitors 117 and 118 of all pixels 11A in the k -th driving block.

[0232] Then, at time t_{25} , the scanning/control line driving circuit 14 simultaneously changes the voltage level of the scanning lines 133 ($k, 1$) to 133 (k, m) from HIGH to LOW to turn off the switching transistors 115.

[0233] Thus, in the period from time t_{20} to time t_{25} , correction of the threshold voltage V_{th} of the driving transistors 114 is performed in the k -th driving block at the same time. It should be noted that the period from time t_0 to time t_5 is equivalent to period T1-1 plus period T1-2 in FIG. 8 described above.

[0234] After time t_{25} , the scanning/control line driving circuit 14 changes the voltage level of the scanning lines 133 ($k, 1$) to 133 (k, m) from LOW to HIGH to LOW in sequence to turn on the switching transistors 115 in one pixel row at a time in order of pixel row. At this time, the signal line driving circuit 15 provides a signal voltage V_{data} to the first signal line 151 through the selector circuit 16. That is, the voltage level

of the first signal line **151** is changed from the standard voltage to the signal voltage (S15 of FIG. 7).

[0235] Specifically, although the first signal line **151** is disconnected from the signal line driving circuit **15** before time **t25** as described with reference to FIGS. 9A and 9B, the first signal line **151** holds the standard voltage by the parasitic capacitance of the first signal line **151**. Then, after a certain period of time has elapsed (that is, after a certain period of time has elapsed from time **t25**), the first signal line **151** is connected to the signal line driving circuit **15** through the selector circuit **16** and provided with a signal voltage V_{data} . It should be noted that, at time **t25**, the signal line driving circuit **15** is outputting the standard voltage to the second signal line **152** through the selector circuit **16** as illustrated in FIG. 9C for a certain period of time. Then, the signal line driving circuit **15** outputs the signal voltage V_{data} to the first signal line **151** through the selector circuit **16**.

[0236] This causes the signal voltage V_{data} to be applied to the gate of the driving transistor **114**. At this point in time, the potential V_{gs} , held in the holding capacitor **117** is equal to the difference between V_{data} and the potential defined by Formula 3 given in the first embodiment, that is, V_{gs} defined by the relationship expressed by Formula 4.

[0237] Specifically, a sum voltage that is the sum of a voltage according to the signal voltage V_{data} and a voltage equivalent to the threshold voltage V_{th} of the driving transistor **114** held previously is held in the holding capacitor **117**.

[0238] After the voltage level of the scanning line **133** ($k, 1$) changes from LOW to HIGH to LOW as described above, the scanning/control line driving circuit **14** changes the voltage level of the second control line **131** ($k, 1$) from LOW to HIGH. The operation is repeated, one pixel row after another.

[0239] In this way, after time **t25**, storing of the corrected signal voltage and luminescence production are performed in the k -th driving block, one pixel row after another.

[0240] After time **t26**, production of luminescence by the organic EL elements **113** is performed in the k -th driving block, one pixel row after another. Here, the drain current i_d flowing through the driving transistor **114** is defined by Formula 5 using the voltage V_{gs} , defined by Formula 4 given in the first embodiment minus the threshold voltage V_{th} of the driving transistor **114**. It can be seen from Formula 5 that the drain current i_d for causing the organic EL element **113** to produce luminescence is independent of the threshold voltage V_{th} of the driving transistor **114**.

[0241] As has been described above, by grouping the pixel rows into driving blocks, compensation for the threshold voltages V_{th} of the driving transistors **114** in the same driving block is performed at the same time. This enables synchronization of control of the current path of the driving current from the sources onward in the same driving block. Accordingly, the first control line **132** can be communized in the same driving block.

[0242] While the scanning lines **133** ($k, 1$) to **133** (k, m) are individually connected to the scanning/control line driving circuit **14**, these scanning lines are driven by a driving pulse at the same timing in the threshold compensation period. Therefore, increase of the frequency of the pulse signal outputted from the scanning/control line driving circuit **14** can be minimized and output load on the driving circuit **14** can be reduced accordingly.

[0243] For the same reason as described in the first embodiment, this embodiment has the advantage that a longer luminescence production duty cycle can be ensured than the con-

ventional display device using two signal lines described in Japanese Unexamined Patent Application Publication No. 2008-122633.

[0244] Accordingly, a long-life display device with a sufficiently high luminance and a lower output load on the driving circuit can be implemented.

[0245] It can be appreciated that when the same luminescence production duty cycle is set for the conventional display device that uses two signal lines and the display device that incorporates block driving according to the present invention, the display device in the present invention can provide a longer threshold detection period.

[0246] Operation of the $(k+1)$ -th driving block in the period from time **t28** to time **t35** is the same as that of the k -th driving block and therefore description of the operation will be omitted.

[0247] FIG. 14 is a state transition diagram of driving blocks that are producing luminescence according to the driving method of the second embodiment of the present invention. FIG. 14 illustrates luminescence production periods and non-luminescence-production periods of each driving block in a pixel column. The vertical axis represents a plurality of driving blocks and the horizontal axis represents elapsed time. Here, a non-luminescence-production period includes a threshold voltage correction period described above.

[0248] According to the display device driving method according to the second embodiment of the present invention, a luminescence production period is set for the pixel rows in sequence in the same driving block. Accordingly, the luminescence production periods appear continuously from driving block to driving block with respect to a row scanning direction.

[0249] In this way, in the second embodiment, as in the first embodiment, pixel circuits in each of which the switching transistor **116** and the holding capacitor **118** are disposed, the selector circuit disposed between the signal line driving circuit **15** and the signal line group **12**, the disposition of the control lines, scanning lines and signal lines in the pixels grouped into driving blocks, and the control method described above enable the threshold voltage of the driving transistors **114** in the same driving block to be corrected in the same period and at the same timing. Moreover, the provision of the selector circuit can reduce the number of outputs from the signal line driving circuit **15**. The reduction of the number of outputs reduces loads on the scanning/control line driving circuit **14** which outputs a signal controlling conduction and non-conduction of the switch elements and a signal controlling current paths, and loads on the signal line driving circuit **15** which controls a signal voltage, as well as the costs of the driving circuit, and improves panel manufacturing yield. Furthermore, grouping into driving blocks and the two signal lines disposed for each pixel row enable a larger part of one frame time T_f in which all pixels are refreshed to be allocated to a threshold voltage correction period for the driving transistors **114**. This is because a threshold voltage correction period for the $(k+1)$ -th driving block is provided in a period during which a luminance signal is being sampled in the k -th driving block. Thus, the threshold voltage correction period is divided among the driving blocks, rather than being divided among the pixel rows. Accordingly, as the display area is increased, the threshold voltage correction period can be increased relative to one frame time without decreasing the luminescence production duty cycle. Consequently, a driving

current based on an accurately corrected signal voltage flows into the luminescence elements, thereby improving display quality.

[0250] For example, if the display panel 10 is divided into N driving blocks, the threshold voltage correction period that is provided for each pixel is Tf/N at the maximum.

Third Embodiment

[0251] The third embodiment of the present invention will be described below with reference to drawings.

[0252] An electrical configuration of a display device according to this embodiment is similar to the configuration illustrated in FIG. 1 with the only difference being the circuit configuration of each pixel. Specifically, the display device according to this embodiment includes a display panel 10 and a control circuit 20. The display panel 10 includes a plurality of pixels 21A and 21B, which will be described later, a signal line group 12, a set of control lines 13, a scanning/control line driving circuit 14, a signal line driving circuit 15, and a selector circuit 16.

[0253] In the following, description of the same components as those of the first and second embodiments will be omitted and only components relating to the pixels 21A and 21B will be described.

[0254] The pixels 21A and 21B are arranged in a matrix on the display panel 10. Here, the pixels 21A and 21B make up two or more driving blocks each including a plurality of pixel rows. The pixels 21A make up an odd-numbered driving block and the pixels 21B make up an even-numbered driving block.

[0255] FIG. 15A is a circuit diagram specifically illustrating a pixel in an odd-numbered driving block in the display device according to the third embodiment of the present invention. FIG. 15B is a circuit diagram specifically illustrating a pixel in an even-numbered driving block in the display device according to the third embodiment of the present invention. The pixel circuits illustrated in FIGS. 15A and 15B differ from the pixel circuits of the first embodiment illustrated in FIGS. 2A and 2B in that a switching transistor 216 is attached instead of the switching transistor 116. Similarly, the current control unit 200 differs from the current control unit 100 according to the first embodiment in that a switching transistor 216 is attached instead of the switching transistor 116. Description of the same components as those of the display device illustrated in FIGS. 2A and 2B will be omitted here.

[0256] Each of organic EL elements 213 in FIGS. 15A and 15B is a luminescence element for example having a cathode connected to a power source line 112, which is a negative power source line, and an anode connected to a source of a driving transistor 214, and produces luminescence when a driving current of the driving transistor 214 flows through the organic EL element 213.

[0257] The switching transistor 216 is a fourth switching transistor having a gate connected to a second control line 231. One of a source and a drain of the switching transistor 216 is connected to one terminal of a holding capacitor 217 and the other of the source and the drain is connected to the source of the driving transistor 214. The switching transistor 216 has the function of causing the holding capacitor 217 to hold a voltage corresponding to an accurate signal voltage by turning off during a period in which the signal voltage from a signal line is stored. On the other hand, during a threshold voltage detection period and a luminescence production

period, the switching transistor 216 turns on to connect the source of the driving transistor 214 to the holding capacitor 217, which is a third capacitive element, and to a holding capacitor 218, which is a fourth capacitive element, to cause the holding capacitor 217 to hold a charge accurately corresponding to a threshold voltage and a signal voltage and to cause the driving transistor 214 to supply a driving current in which the voltage held in the holding capacitor 217 is reflected to the luminescence element.

[0258] The second control line 231 is connected to a scanning/control line driving circuit 14 and to the pixels belonging to a pixel row including the pixels 21A and 21B. Thus, the second control line 231 has the function of producing a state for bringing the source of the driving transistor 214 and a node between the holding capacitor 217 and the holding capacitor 218 into or out of conduction.

[0259] A first control line 232 is connected to the scanning/control line driving circuit 14 and to the pixels belonging to the pixel row including the pixels 21A and 21B. Thus, the first control line 232 has the function of switching a voltage level to prepare conditions for detecting the threshold voltage of the driving transistor 214.

[0260] Connections of the second control lines 231, the first control lines 232, the scanning lines 233, the first signal lines 251, and the second signal lines 252 among the pixels will be described below.

[0261] FIG. 16 is a circuit diagram illustrating a portion of the display panel of the display device according to the third embodiment of the present invention. FIG. 16 illustrates two adjacent driving blocks, control lines, scanning lines, and signal lines. The control lines, the scanning lines, and the signal lines are denoted by a reference numeral followed by (block number, row number in the block) or a reference numeral followed by (block number) in the figure and the following description.

[0262] As described earlier, a driving block is made up of a plurality of pixel rows and two or more driving blocks exist in the display panel 10. For example, each of the driving blocks depicted in FIG. 16 is made up of m pixel rows.

[0263] In the k-th driving block illustrated in the upper part of FIG. 16, second control lines 231 ($k, 1$) to 231 (k, m) are disposed in each pixel row in the driving block and are each individually connected to the gate of the switching transistor 216 of each pixel 21A. A first control line 232 (k) is connected to holding capacitors 218 of all pixels 21A in the driving block in common. On the other hand, scanning lines 233 ($k, 1$) to 233 (k, m) are each individually connected to each pixel row.

[0264] In the (k+1)-th driving block illustrated in the lower part of FIG. 16, connections similar to those of the k-th driving block are made. However, the first control line 232 ($k+1$) connected to the (k+1)-th driving block is a control line different from the first control line 232 (k) connected to the k-th driving block and individual control signals are outputted from the scanning/control line driving circuit 14 to first control lines 232 (k) and ($k+1$).

[0265] In the k-th driving block, a first signal line 251 is connected to one of a source and a drain of a switching transistor 215 of every pixel 21A in the driving block. On the other hand, in the (k+1)-th driving block, a second signal line 252 is connected to one of a source and a drain of a switching transistor 215 of every pixel 21B in the driving block.

[0266] As described earlier, grouping into driving blocks reduces the number of first control lines 232 which control V_{th}

detection circuits. Accordingly, size of the scanning/control line driving circuit 14 which outputs driving signals to the control lines is reduced. Furthermore, a longer V_{th} detection time can be ensured to increase the accuracy of detection of V_{th} , increasing the quality of display.

[0267] In this embodiment, as in the embodiment in FIG. 1, the selector circuit 16 is provided and output lines of the signal line driving circuit 15 are connected to the first signal lines 151 and the second signal lines 152 through the selector circuit 16.

[0268] A method for driving the display device according to this embodiment will be described below with reference to FIG. 17. Here, the driving method for the display device having the specific circuit configuration illustrated in FIGS. 15A and 15B will be described in detail.

[0269] FIG. 17 is a timing chart of an operation of a display device driving method according to the third embodiment of the present invention. The horizontal axis of the timing chart represents time.

[0270] Shown in FIG. 17 in rows are, in order from top, waveforms of voltages appearing on the scanning lines 233 ($k, 1$), 233 ($k, 2$), and 233 (k, m), the second control lines 231 ($k, 1$), 231 ($k, 2$) and 231 (k, m), the first control line 232 (k), and the first signal line 251 in the k -th driving block. Following these are waveforms of voltages appearing on the scanning lines 233 ($k+1, 1$), 233 ($k+1, 2$), and 233 ($k+1, m$), the second control lines 231 ($k+1, 1$), 231 ($k+1, 2$) and 231 ($k+1, m$), the first control line 232 ($k+1$), and the second signal line 252 in the ($k+1$)-th driving block. FIG. 17 illustrates that signal voltages for luminescence production periods in the $k-4$ -th, $k-2$ -th, and k -th driving blocks, in order from left to right, are appearing on a first signal line 251. FIG. 17 also illustrates that signal voltages for luminescence production periods in the $k-3$ -th, $k-1$ -th, and $k+1$ -th driving blocks are appearing on a second signal line 252. That is, FIG. 17 illustrates that the standard voltage and signal voltage are alternately appearing on the first signal line 251 and the second signal line 252.

[0271] FIG. 18 is a state transition diagram of a pixel of the display device according to third embodiment of the present invention. FIG. 19 is a flowchart of an operation of the display device according to the third embodiment of the present invention.

[0272] First, at time $t40$, the voltage level of the scanning line 233 ($k, 1$) is changed to HIGH to apply a standard voltage from the first signal line 251 to the gate of the driving transistor 214 (S31 of FIG. 19). At this point in time, the voltage level of the first signal line 251 is changed from a signal voltage to a standard constant voltage.

[0273] Here, a method for using the selector circuit 16 to change a voltage of the first signal line 251 from the signal voltage to the standard voltage will be described. FIG. 20 is a timing chart of an operation for driving the selector circuit of the display device according to the third embodiment of the present invention. Differences of the operation in FIG. 20 from the operation in FIG. 8 are as follows. In four driving blocks, namely the k -th to $k+3$ -th driving blocks, the voltage levels of scanning lines 233 in the corresponding driving blocks are sequentially driven and held HIGH for certain periods of time in non-luminescence-production periods after a signal voltage is applied. As a result, the standard potential is applied to the gates of the driving transistors 214 to turn off the driving transistors 214. The rest is the same as the opera-

tion described with reference to FIG. 8 and therefore description the same operation will be omitted.

[0274] Specifically, the first signal line 251 is provided with a signal voltage from the signal line driving circuit 15 through the selector circuit 16 at a time a certain time period before time $t40$ and provided with a standard voltage through the selector circuit 16 the certain time period before time $t40$. Then, the first signal line 251 is disconnected from the signal line driving circuit 15 by the selector circuit 16 at time $t40$ but holds the standard voltage by the parasitic capacitance of the first signal line 251. Thus, the first signal line 251 holds the standard voltage until the first signal line 251 is subsequently connected to the signal line driving circuit 15 through the selector circuit 16 and provided with a signal voltage.

[0275] In other words, in a certain period of time before time $t40$, the standard voltage is provided from the data driver 150 to the first signal line 251 and is stored (SAMPLE) in the parasitic capacitance of the first signal line 251 as illustrated in FIG. 9A. The first signal line 251 holds the standard voltage as illustrated in FIG. 9B until the first signal line 251 is connected to the signal line driving circuit 15 through the selector circuit 16 and provided with a signal voltage. On the other hand, the second signal line 252 is being supplied with a signal voltage from the data driver 150 during this period and the pixels in the $k-2$ -th driving block connected to the second signal line 252 produce luminescence according to the signal voltage provided.

[0276] Here, the standard voltage is 0 V, for example, as shown in FIG. 18(a). The driving block is in luminescence production mode immediately before time $t40$. The source potential V_s of the driving transistor 214 in this steady state is denoted by V_{EL} . Because of this state and because the voltage level of the second control line 231 ($k, 1$) is HIGH to keep the switching transistor 216 in conduction, $V_{gs} = -V_{EL} < V_T$ (TFT). Therefore, the driving transistor 214 turns off.

[0277] Then, at time $t41$, the voltage level of the scanning line 233 ($k, 1$) is changed to LOW. Then, while the first signal line 251 in the k -th driving block is held at the standard voltage, the voltage level of the scanning line 233 is changed from LOW to HIGH to LOW in sequence one pixel row after another to optically quench the organic EL elements 213 in one pixel row at a time in order of pixel row. That is, luminescence production in the pixels in the k -th driving block ends in order, one pixel row after another, while at the same time non-luminescence-production in the k -th driving block starts, one pixel row after another.

[0278] Then, at time $t42$, the scanning/control line driving circuit 14 changes the voltage level of the first control line 232 (k) from LOW to HIGH and, after a predetermined time period has elapsed, changes the voltage level to LOW (S32 of FIG. 19). During this time, the voltage level of the second control lines 231 ($k, 1$) to 231 (k, m) is held HIGH. Here, assume that the voltage of the first control line 232 (k) is changed by $\Delta V_{reset} (>0)$ while the switching transistor 215 is off, and the capacitance value of the holding capacitor 218 is C_2 , the capacitance and threshold voltage of the organic EL element 213 are C_{EL} and V_T (EL), respectively. Then, at the instant when the voltage level of the first control line 232 (k) is changed to HIGH, the potential V_s at the source electrode S (M) of the driving transistor 214 becomes equal to the sum of the voltage divided by C_2 and C_{EL} plus V_T (EL):

[Math. 11]

$$V_S = \frac{C_2}{C_2 + C_{EL}} \Delta V_{reset} + V_{T(EL)} \quad (\text{Formula 11})$$

Then, the organic EL element **213** starts self-discharge as illustrated in FIG. **18(b)** and accordingly V_s gradually approaches V_T (EL) in a steady state.

[0279] Then, at time **t43**, the scanning/control line driving circuit **14** simultaneously changes the voltage level of the scanning lines **233** ($k, 1$) to **233** (k, m) to HIGH. At this point in time, the signal line driving circuit **15** changes the voltage level of the first signal line **251** from the signal voltage to the standard voltage. The method for using the selector circuit **16** to change the voltage of the first signal line **251** from the signal voltage to the standard voltage is the same as the method for changing the voltage of the first signal line **251** from the signal voltage to the standard voltage at time **t40** and therefore description of the method will be omitted here.

[0280] Then, the scanning/control line driving circuit **14** changes the voltage level of the first control line **232** (k) from HIGH to LOW to bias V_s as:

[Math. 12]

$$V_S = V_{T(EL)} - \frac{C_2}{C_2 + C_2 + C_{EL}} \Delta V_{reset} \quad (\text{Formula 12})$$

The change from HIGH to LOW of the first control line **232** (k) causes a gate-source voltage V_{gs} , higher than the threshold voltage V_{th} of the driving transistor **214** to appear between the gate and source of the driving transistor **214**. That is, a potential difference that enables the threshold voltage of the driving transistor to be detected is caused to appear at the holding capacitor **217**. Thus, preparation for a threshold voltage detection stage is completed. At the same time, the driving transistor **214** turns on as illustrated in FIG. **18(c)** to allow a drain-source current to flow into the holding capacitors **217** and **218** and the organic EL element **213**. At this point in time, V_s defined by Formula 2 starts to gradually approach $-V_{th}$. As a result, V_{th} of the driving transistor **214** is held in the holding capacitors **217** and **218**. Note that the current flowing into the organic EL element **213** at this time is not a current for causing the organic EL element **213** to produce luminescence because the anode potential is lower than $-V_{th}$, the cathode potential is 0 V, and therefore the organic EL element **213** is reverse biased.

[0281] In the period from time **t43** to **t44**, the circuits of the pixels **21A** are in the steady state and a voltage equivalent to the threshold voltage V_{th} of the driving transistor **214** is held in the holding capacitors **217** and **218**. Note that since current flowing to cause the holding capacitors **117** and **118** to hold the voltage equivalent to the threshold voltage V_{th} is small, it takes time for the circuit to be placed in the steady state. The longer the time, the more stabilized the voltage held in the holding capacitor **117** becomes. By providing a sufficiently long time for this period, accurate voltage compensation can be achieved.

[0282] Then, at time **t44**, the scanning/control line driving circuit **14** simultaneously changes the voltage level of the scanning lines **233** ($k, 1$) to **233** (k, m) from HIGH to LOW

(**533** of FIG. **19**). This completes the holding of V_{th} of the driving transistor **214** in the holding capacitors **217** and **218**. At this point in time, a voltage equivalent to the threshold voltage V_{th} of the driving transistor **214** is simultaneously held in the holding capacitors **217** and **218** of all the pixels **21A** in the k -th driving block. Note that immediately before time **t44**, the second control lines **231** ($k, 1$) to **231** (k, m) have been simultaneously changed to LOW to turn off the switching transistor **216**. This prevents a leak current of the driving transistor **214** into the holding capacitors **217** and **218** to change the value of the threshold voltage V_{th} of the driving transistor **214** held in the holding capacitors **217** and **218** after the threshold voltage V_{th} has been detected.

[0283] In this way, the threshold voltages of the driving transistors **214** are corrected at the same time in the k -th driving block in the period from time **t43** to time **t44**.

[0284] Then, after time **t44**, the scanning/control line driving circuit **14** changes the voltage level of the scanning lines **233** ($k, 1$) to **233** (k, m) from LOW to HIGH to LOW in sequence to turn on the switching transistors **215**, one pixel row after another. During this time, the signal line driving circuit **15** changes the voltage level of the first signal line **251** to a signal voltage V_{data} according to the luminance value for each pixel (**S34** of FIG. **19**).

[0285] In a certain period of time before time **t43** in FIG. **17**, the standard voltage is provided from the data driver **150** to the first signal line **251** and is stored (SAMPLE) in the parasitic capacitance of the first signal line **251** as illustrated in FIG. **9A**. The first signal line **251** holds the standard voltage as illustrated in FIG. **9B** until time **t53**, that is, until the first signal line **251** is connected to the signal line driving circuit **15** through the selector circuit **16** and provided with a signal voltage. On the other hand, a signal voltage is being provided from the data driver **150** to the second signal line **152** for the period of time until time **t44** and the pixels that are connected to the second signal line **152** start producing luminescence according to the signal voltage provided.

[0286] At time **t44**, the standard voltage is provided from the data driver **150** to the second signal line **252** and is stored (SAMPLE) in the parasitic capacitance of the second signal line **252** as illustrated in FIG. **9C** for a certain period of time and the second signal line **252** holds (HOLD) the standard voltage as illustrated in FIG. **9D**. On the other hand, a signal voltage is provided from the data driver **150** to the first signal line **251** a certain period of time after time **t44** and the pixels connected to the first signal line **251** start producing luminescence according to the signal voltage provided. As a result, the signal voltage V_{data} is applied to the gates of the driving transistors **214** as illustrated in FIG. **18(d)**. At this point in time, the potential V_M at a contact M between the holding capacitors **217** and **218** is equal to V_{data} divided by C_1 and C_2 plus $-V_{th}$ which is V_s potential at time **t44**:

[Math. 13]

$$\begin{aligned} V_M &= \frac{C_1}{C_1 + C_2} \Delta V_{data} - V_{th} \\ &= \frac{C_1}{C_1 + C_2} (V_{data} - 0) - V_{th} \\ &= \frac{C_1}{C_1 + C_2} \Delta V_{data} - V_{th} \end{aligned} \quad (\text{Formula 13})$$

[0287] Specifically, the potential difference V_{gM} held in the holding capacitor 217 is the difference between V_{data} and the potential defined by Formula 13:

[Math. 14]

$$V_{gM} = \frac{C_2}{C_1 + C_2} V_{data} + V_{th} \quad (\text{Formula 14})$$

[0288] That is, a sum voltage that is the sum of a voltage according to the signal voltage V_{data} and a voltage equivalent to the threshold voltage V_{th} of the driving transistor 214 held previously is held in the holding capacitor 217.

[0289] After time t46, the scanning/control line driving circuit 14 changes the voltage level of the control lines 231 ($k, 1$) to 231 (k, m) from LOW to HIGH in sequence to turn on the switching transistors 216 in one pixel row at a time in order of pixel row (S35 of FIG. 19). As a result, the voltage defined by Formula 13 is applied between the gate and source of the driving transistor 214 and a drain current shown in FIG. 18(e) flows to cause luminescence production according to the threshold-corrected signal voltage in one pixel row at a time.

[0290] In this way, store of the corrected signal voltage and luminescence production are performed in one pixel row at a time in order of pixel row in the k-th driving block after time t46.

[0291] Here, the drain current i_d flowing through the driving transistor 214 can be expressed using the voltage that is equal to V_{gM} defined by Formula 14 minus the threshold voltage V_{th} of the driving transistor 214 as follows:

[Math. 15]

$$i_d = \frac{\beta}{2} \left(\frac{C_2}{C_1 + C_2} V_{data} \right) \quad (\text{Formula 15})$$

Here, β is a characteristic parameter relating to mobility. It can be seen from Formula 15 that the drain current i_d for causing the organic EL element 213 to produce luminescence is independent of the threshold voltage V_{th} of the driving transistor 214 and is not related to a capacitive component of the organic EL element 213.

[0292] As described above, since the pixel rows are grouped into driving blocks, the threshold voltages V_{th} of the driving transistors 214 in the same driving block are compensated for at the same time. Accordingly, control of current paths of the driving current from the sources onward can be synchronized in the same driving block. Thus, the first control line 232 can be shared in the same driving block.

[0293] While the scanning lines 233 ($k, 1$) to 233 (k, m) are individually connected to the scanning/control line driving circuit 14, these scanning lines are driven by a driving pulse at the same timing in the threshold voltage compensation period. Therefore, increase of the frequency of the pulse signal outputted from the scanning/control line driving circuit 14 can be minimized and output load on the driving circuit 14 can be reduced accordingly.

[0294] Furthermore, only one output line of the signal line driving circuit 15 needs to be provided for two signal lines disposed in each pixel column. Accordingly, the size of the signal line driving circuit 15 can be reduced. The reduction of the number of data drivers 153 and the number of output lines

reduces the cost for mounting of the driving circuit and improves manufacturing yield.

[0295] For the same reason as described in the first embodiment, this embodiment has the advantage that a longer luminescence production duty cycle can be ensured than the conventional display device using two signal lines described in Japanese Unexamined Patent Application Publication No. 2008-122633.

[0296] Accordingly, a long-life display device with a sufficiently high luminance and a lower output load on the driving circuit can be implemented.

[0297] It can be appreciated that when the same luminescence production duty cycle is set for the conventional display device that uses two signal lines and the display device that incorporates block driving according to the present invention, the display device in the present invention can provide a longer threshold detection period.

[0298] Operation of the (k+1)-th driving block in the period after time t50 is the same as that of the k-th driving block and therefore description of the operation will be omitted. State transitions of driving blocks described above are the same as in the state transition diagram in FIG. 14 and therefore the description of the state transitions will be omitted.

[0299] The operation described above is performed on the (k+2)-th and the subsequent driving blocks in the display panel 10 in sequence.

[0300] According to the display device driving method of the third embodiment of the present invention, luminescence production periods are set for the pixel rows in sequence in the same driving block. Accordingly, the luminescence production periods appear continuously in the driving block with respect to a row scanning direction.

[0301] In the third embodiment, as in the first and second embodiments, pixel circuits in each of which the switching transistor 216 and the holding capacitor 218 are disposed, the selector circuit disposed between the signal line driving circuit 15 and the signal line group 12, the disposition of the control lines, scanning lines and signal lines in the pixels grouped into driving blocks, and the driving method described above enable the threshold voltage of the driving transistors 214 in the same driving block to be corrected in the same period and at the same timing. Moreover, the provision of the selector circuit can reduce the number of outputs from the signal line driving circuit 15. The reduction of the number of outputs reduces loads on the scanning/control line driving circuit 14 which outputs a signal controlling conduction and non-conduction of the switch elements and a signal controlling current paths, and loads on the signal line driving circuit 15 which controls a signal voltage, as well as the costs of the driving circuit, and improves panel manufacturing yield. Furthermore, grouping into driving blocks and the two signal lines disposed for each pixel row enable a larger part of one frame time T_f in which all pixels are refreshed to be allocated to a threshold voltage correction period for the driving transistors 114. This is because a threshold voltage correction period for the (k+1)-th driving block is provided in a period during which a luminance signal is being sampled in the k-th driving block. Thus, the threshold voltage correction period is divided among the driving blocks, rather than being divided among the pixel rows. Accordingly, as the display area is increased, the threshold voltage correction period can be increased relative to one frame time without decreasing the luminescence production duty cycle. Consequently, a driving

current based on an accurately corrected signal voltage flows into the luminescence elements, thereby improving display quality.

[0302] For example, if the display panel 10 is divided into N driving blocks, the threshold voltage correction period that is provided for each pixel is Tf/N at the maximum.

Fourth Embodiment

[0303] An electrical configuration of a display device according to this embodiment is similar to the configuration illustrated in FIG. 1 with the only difference being the circuit configuration of each pixel. Specifically, the display device according to this embodiment includes a display panel 10 and a control circuit 20. The display panel 10 includes a plurality of pixels 31A and 31B, which will be described later, a signal line group 12, a set of control lines 13, a scanning/control line driving circuit 14, a signal line driving circuit 15, and a selector circuit 16.

[0304] The set of control lines 13 includes scanning lines, control lines, and power source lines that are disposed in each pixel.

[0305] A scanning/control line driving circuit 14 outputs a scanning signal to each scanning line in the set of control lines 13, a control signal to each of the control line in the set of control lines 13, and a variable voltage to each of power source lines to drive the circuit elements of the pixels.

[0306] The pixels 31A and 31B are arranged in a matrix on the display panel 10. Here, the pixels 31A and 31B make up two or more driving blocks each including a plurality of pixel rows. The pixels 31A make up an odd-numbered driving block and the pixels 31B make up an even-numbered driving block.

[0307] In the following, description of the same components as those of the first to third embodiments will be omitted and only components relating to the pixels 31A and 31B will be described.

[0308] FIG. 21A is a circuit diagram specifically illustrating a pixel in an odd-numbered driving block in the display device according to the fourth embodiment of the present invention. FIG. 21B is a circuit diagram specifically illustrating a pixel in an even-numbered driving block in the display device according to the fourth embodiment of the present invention. Each of the pixels 31A and 31B illustrated in FIGS. 21A and 21B includes an organic EL element 312, a driving transistor 314, holding capacitors 316 and 317, a switching transistor 315, a scanning line 333, a first signal line 351, and a second signal line 352. Each of the pixels 31A and 31B further includes a selecting transistor 315. The pixel circuits illustrated in FIGS. 21A and 21B differ from the pixel circuits illustrated in FIGS. 2A and 2B in that the switching transistor 116 is not disposed in the pixels 21A and 21B. The driving transistor 314 and the holding capacitors 316 and 317 form a current control unit 300. Description of the same components as those of the display device illustrated in FIGS. 2A and 2B will be omitted below.

[0309] Each organic EL element 313 is a luminescence element for example having a cathode connected to the power source line 312, which is a second power source line, and an anode connected to a source of the driving transistor 314, and produces luminescence when a driving current of the driving transistor 314 flows through the organic EL element 313.

[0310] The driving transistor 314 has a drain connected to a power source line 310 and a gate connected to a first electrode of the holding capacitor 316. When a voltage corresponding

to a signal voltage is applied to the gate of the driving transistor 314, the driving transistor 314 converts the voltage to a drain current corresponding to the voltage. The drain current is provided to the organic EL element 313 as a driving current. The driving transistor 314 is implemented by an n-type thin-film transistor (n-type TFT).

[0311] The switching transistor 115 has a gate connected to a scanning line 333. One of the source and drain of the switching transistor 115 is connected to the gate of the driving transistor 314. The other of the source and drain of the switching transistor 115 in an odd-numbered driving block is connected to the first signal line 351, so that the switching transistor 115 functions as a first switching element; in an even-numbered driving block, the other of the source and the drain is connected to the second signal line 352, so that the switching transistor 115 functions as a second switching element.

[0312] One terminal of the holding capacitor 316 is a sixth capacitive element one terminal of which is connected to the gate of the driving transistor 314 and the other terminal is connected to the source of the driving transistor 314. The holding capacitor 316 has the function of holding charge corresponding to a signal voltage provided through the first signal line 351 or the second signal line 352 and, after the switching transistor 115 is turned off, for example, controlling a driving current provided from the driving transistor 314 to the organic EL element 313.

[0313] The holding capacitor 316 is connected to the gate of the driving transistor 314 and to the switching transistor 115 and has the function of detecting a threshold voltage of the driving transistor 314. The holding capacitor 317 is a holding capacitive element which is connected between the other terminal of the holding capacitor 316 and a reference voltage source (which is illustrated as reference voltage V_{ref} in FIGS. 21A and 21B but may be the power source line 312). In a steady state, the holding capacitor 317 first holds a source potential of the driving transistor 314 so that information on the source potential remains at a node between the holding capacitors 316 and 317 after a signal voltage is applied from the switching transistor 115. It should be noted that the source potential at this timing is the threshold voltage of the driving transistor 314. When subsequently the timing between the holding of the threshold voltage and luminescence production varies among pixel rows, a gate voltage of the driving transistor 314 is fixed because the potential at the other terminal of the holding capacitor 316 is fixed. On the other hand, the source potential of the driving transistor 314 is already in a steady state. Thus, the holding capacitor 317 has the function of holding the source potential of the driving transistor 314 in effect.

[0314] It should be noted that the holding capacitor 317 does not necessarily need to be attached as an independent circuit element; the holding capacitor 317 may be a parasitic capacitance of the organic EL element 313.

[0315] The power source line 310 provides a first voltage or a second voltage to the drain of the driving transistor 314. The first voltage is lower than a standard voltage provided through the first signal line 351 and the second signal line 352. Application of the first voltage to the drain of the driving transistor 314 can reset the source potential of the driving transistor 314. The second voltage is higher than the standard voltage. Application of the second voltage to the drain of the driving transistor 314 can cause the holding capacitor 316 to hold a voltage corresponding to the threshold voltage or can provide a driving current corresponding to a signal voltage to cause

the organic EL element **313** to produce luminescence. The control circuit **20** makes up a control unit that controls operation of each pixel in conjunction with the scanning/control line driving circuit **14** and the signal line driving circuit **15** to control timings of turning on and off the selecting transistors of the selector circuit **16**.

[0316] The control circuit **20** also controls the timings of providing the first and second voltages.

[0317] In this embodiment, as in the embodiment in FIG. 1, the selector circuit **16** is provided and output lines of the signal line driving circuit **15** are connected to the first signal lines **351** and the second signal lines **352** through the selector circuit **16**.

[0318] A display device driving method according to this embodiment will be described with reference to FIG. 22. Here, a method for controlling a display device having the specific configuration illustrated in FIGS. 21A and 21B will be described. It is assumed here that each driving block includes m pixel rows.

[0319] FIG. 22 is a timing chart of an operation of the display device driving method according to the fourth embodiment of the present invention. The horizontal axis of the timing chart represents time. Shown in FIG. 22 in rows are, in order from top, waveforms of voltages appearing on a scanning line **333** (k, m) disposed in the first row of the k -th driving block, a scanning line **330** ($k, 2$) disposed in the second row, and a scanning line **333** (k, m) disposed in the m -th row, a first signal line **351**, a power source line **310** ($k, 1$) disposed in the first row of the k -th driving block, a power source line **310** ($k, 2$) disposed in the second row, and a power source line **310** (k, m) disposed in the m -th row. Following these are waveforms of voltages appearing on a scanning line **333** ($k+1, 1$) disposed in the first row of the ($k+1$)-th driving block, a scanning line **333** ($k+1, 2$) disposed in the second row, and a scanning line **333** ($k+1, m$) disposed in the m -th row, a second signal line **352**, a power source line **110** ($k+1, 1$) disposed in the first row of the ($k+1$)-th driving block, a power source line **310** ($k+1, 2$) disposed in the second row, and a power source line **310** ($k+1, m$) disposed on the m -th row. FIG. 23 is a flowchart of an operation of the display device according to the fourth embodiment of the present invention.

[0320] First, by time $t61$, the control circuit **20** sets the voltage level of the power source lines **310** ($k, 1$) to **310** (k, m) to LOW, which is the first voltage lower than the standard voltage, in sequence to reset the source potentials of the driving transistors **314** (S51 of FIG. 23). Here, the first voltage is -10 V, for example, and the source potential of the driving transistor **314** is reset to -10 V.

[0321] Then, at time $t62$, the control circuit **20** simultaneously changes the voltage level of the scanning lines **333** ($k, 1$) to **333** (k, m) from LOW to HIGH to turn on the selecting transistors **315** (S52 of FIG. 23). At this point in time, the control circuit **20** has changed the voltage level of the first signal line **351** from the signal voltage to the standard voltage.

[0322] Here, the timing chart of an operation for driving the selector circuit according to this embodiment is the same as the timing chart of the operation described in the first embodiment and shown in FIG. 8.

[0323] That is, at time $t62$, the standard voltage is provided from the data driver **150** to the first signal line **351** and is stored (SAMPLE) in the parasitic capacitance of the first signal line **351** as illustrated in FIG. 9A for a certain period of time. The first signal line **351** holds the standard voltage as illustrated in FIG. 9B until time $t65$. On the other hand, a

signal voltage is being provided from the data driver **150** to the second signal line **352** until time $t64$ and the pixels that are connected to the second signal line **352** start producing luminescence according to the signal voltage provided. In this way, the standard signal voltage held on the signal line **351** is applied to the gate of the driving transistors **314** through the switching transistors **315** in the on state. Here, the standard voltage is 0 V, for example.

[0324] Then, at time $t63$, the control circuit **20** changes the voltage level of the power source lines **310** ($k, 1$) to **310** (k, m) from the first voltage to the second voltage, which is higher than the standard voltage (S53 of FIG. 23). Here, the second voltage is 10 V, for example. Thus, preparation for a threshold voltage detection stage is completed.

[0325] In the period from time $t63$ to time $t64$, the circuit of each pixel **31A** is placed in a steady state, and a voltage equivalent to the threshold voltage of the driving transistor **314** is held in the holding capacitor by time $t64$. It should be noted that since current flowing to cause the holding capacitor **316** to hold the voltage equivalent to the threshold voltage V_{th} is small, it takes time for the circuits to be placed in the steady state. The longer the time, the more stabilized the voltage held in the holding capacitor **316** becomes. By providing a sufficiently long time for this period, accurate voltage compensation can be achieved.

[0326] Then, at time $t64$, the control circuit **20** simultaneously changes the voltage level of the scanning lines **333** ($k, 1$) to **333** (k, m) from HIGH to LOW to turn off the selecting transistors **315** (S14 of FIG. 23). This discontinues the application of the standard voltage to the driving transistor **314**. At this point in time, a voltage equivalent to the threshold voltage V_{th} of the driving transistor **314** is simultaneously held in the holding capacitors **316** of all the pixels **31A** in the k -th driving block and the threshold voltage V_{th} of the driving transistor **314** that is to be compensated for is determined.

[0327] In this way, correction of the threshold voltage V_{th} of the driving transistors **314** in the k -th driving block is simultaneously performed in the period from time $t61$ and time $t64$.

[0328] Then, at time $t65$, the control circuit **20** changes the voltage level of the first signal line **351** from the standard voltage to the signal voltage.

[0329] Specifically, in a certain period of time before time $t65$, the standard voltage is provided from the data driver **150** to the second signal line **352** and is stored (SAMPLE) in the parasitic capacitance of the second signal line **352** as illustrated in FIG. 9C. The second signal line **352** holds the standard voltage as illustrated in FIG. 9D from time $t65$. On the other hand, from time $t65$, the signal voltage is provided from the data driver **150** to the first signal line **351** to cause the pixels connected to the first signal line **351** to start producing luminescence according to the signal voltage provided. As a result, the signal voltage is applied to the gates of the driving transistors **314**. Here, the signal voltage is in the range of 0 V to 5 V, for example.

[0330] In the period from time $t65$ to time $t66$, the control circuit **20** changes the voltage level of the scanning lines **333** ($k, 1$) to **333** (k, m) from LOW to HIGH to LOW in sequence to turn on the selecting transistors **315** in one pixel row at a time in order of pixel row (S55 of FIG. 23). As a result, the signal voltage is applied to the gate of each driving transistor **314**. At this point in time, the sum voltage that is equal to the sum of a voltage according to the signal voltage plus a voltage equivalent to the threshold voltage V_{th} of the driving transistor **314** previously held is held in the holding capacitor **316**. At

the same time, a driving current of the driving transistor **314** flows into the organic EL elements **313** to cause the organic EL elements **313** to produce luminescence in order of pixel row.

[0331] In this way, store of an accurately corrected signal voltage and luminescence production are performed in the k-th driving block in order of pixel row in the period from time $t65$ to $t66$.

[0332] After time $t16$, the control circuit **20** changes the voltage level of the power source lines **310** ($k, 1$) to **310** (k, m) in the k-th driving block from the second voltage to the first voltage in order of pixel row to optically quench the pixels in one pixel row at a time in order of pixel row.

[0333] As has been described above, by grouping the pixel rows into driving blocks, detection of the threshold voltages of the driving transistors **314** in the same driving block is performed at the same time and accordingly a time period equal to one frame time divided by the number of driving blocks can be allocated as a threshold voltage detection period at the maximum. Consequently, an accurately corrected driving current flows into the organic EL elements **313**, improving the image display quality. Furthermore, the control circuit **20** can perform simultaneous control in the same driving block in the threshold voltage detection period, that is, can output the same control signal to the same driving block. Furthermore, by providing the selector circuit **16**, only one output line of the signal line driving circuit **15** needs to be provided for two signal lines disposed in each pixel column. Accordingly, the size of the signal line driving circuit **15** can be reduced. The reduction of the number of data drivers **153** and the number of output lines reduces the cost for mounting of the driving circuit and improves manufacturing yield.

[0334] For the same reason as described in the first embodiment, this embodiment has the advantage that a longer luminescence production duty cycle can be ensured than the conventional display device using two signal lines described in Japanese Unexamined Patent Application Publication No. 2008-122633.

[0335] Accordingly, a long-life display device with a sufficiently high luminance and a lower output load on the driving circuit can be implemented.

[0336] It can be appreciated that when the same luminescence production duty cycle is set for the conventional display device that uses two signal lines and the display device that incorporates block driving according to the present invention, the display device in the present invention can provide a longer threshold detection period.

[0337] Operation of the (k+1)-th driving block in the period from time $t71$ to $t76$ is the same as that of the k-th driving block and therefore description of the operation will be omitted.

[0338] The operation described above is performed on the (k+2)-th and the subsequent driving blocks in the display panel **10** in sequence.

[0339] Since state transitions of driving blocks producing luminescence by the driving method according to this embodiment is the same as in state transition diagram in FIG. **14** and therefore the description of the state transitions will be omitted.

[0340] According to the display device driving method of the fourth embodiment of the present invention, luminescence production periods are set for the pixel rows in sequence in the same driving block. Accordingly, the lumi-

nescence production periods appear continuously in the driving block with respect to a row scanning direction.

[0341] In this way, in the fourth embodiment, as in the embodiments described earlier, the pixel circuits in each of which the holding capacitor **316** is disposed, the selector circuit **16** disposed between the signal line driving circuit **15** and the signal line group **12**, the disposition of the scanning lines, the power source lines, and the signal lines in the pixels grouped into driving blocks, and the control method described above enable the threshold voltage of the driving transistors **314** in the same driving block to be corrected in the same period and at the same timing. Moreover, the provision of the selector circuit can reduce the number of outputs from the signal line driving circuit **15**. The reduction of the number of outputs reduces loads on the scanning/control line driving circuit **14** which outputs a signal controlling current paths, and loads on the signal line driving circuit **15** which controls a signal voltage, as well as the costs of the driving circuit, and improves panel manufacturing yield. Furthermore, grouping into driving blocks and the two signal lines disposed for each pixel row enable a larger part of one frame time Tf in which all pixels are refreshed to be allocated to a threshold voltage correction period for the driving transistors **314**. This is because a threshold voltage correction period for the (k+1)-th driving block is provided in a period during which a luminance signal is being sampled in the k-th driving block. Thus, the threshold voltage correction period is divided among the driving blocks, rather than being divided among the pixel rows. Accordingly, as the display area is increased, the threshold voltage correction period can be increased relative to one frame time without decreasing the luminescence production duty cycle. Consequently, a driving current based on an accurately corrected signal voltage flows into the luminescence elements, thereby improving display quality.

[0342] For example, if the display panel **10** is divided into N driving blocks, the threshold correction period that is provided for each pixel is Tf/N at the maximum.

Fifth Embodiment

[0343] Another embodiment of the present invention will be described below with reference to drawings.

[0344] An electrical configuration of a display device according to this embodiment is similar to the configuration illustrated in FIG. **1** with the only difference being the circuit configuration of each pixel. Specifically, the display device according to this embodiment includes a display panel **10** and a control circuit **20**. The display panel **10** includes a plurality of pixels **41A** and **41B**, which will be described later, a signal line group **12**, a set of control lines **13**, a scanning/control line driving circuit **14**, a signal line driving circuit **15**, and a selector circuit **16**.

[0345] The pixels **41A** and **41B** are arranged in a matrix on the display panel **10**. Here, the pixels **41A** and **41B** make up two or more driving blocks each including a plurality of pixel rows. The pixels **41A** make up an odd-numbered driving block and the pixels **41B** make up an even-numbered driving block.

[0346] In the following, description of the same components as those of the first to third embodiments will be omitted and only components relating to the pixels **41A** and **41B** will be described.

[0347] FIG. **24A** is a circuit diagram specifically illustrating a pixel in an odd-numbered driving block in the display device according to the fifth embodiment of the present inven-

tion. FIG. 24B is a circuit diagram specifically illustrating a pixel in an even-numbered driving block in the display device according to the fifth embodiment of the present invention. Each of the pixels 41A and 41B depicted in FIGS. 24A and 24B includes an organic EL element 413, a driving transistor 414, switching transistors 415, 416, and 417, a holding capacitor 418, a control line 431, a scanning line 433, a first signal line 451, and a second signal line 452. Here, the driving transistors 414, the switching transistors 415, 416, and 417, and the holding capacitor 418 make up a current control unit 400. The current control unit 400 has the function of converting a signal voltage provided through the first signal line 451 or the second signal line 452 to a signal current, which is a source-drain current of the driving transistor 414.

[0348] Each of the switching transistors 416 in FIGS. 24A and 24B is a fifth switching transistor having a gate connected to a scanning line 433. One of a source and a drain of the switching transistor 416 is connected to a gate of the driving transistor 414 and a first electrode which is one terminal of the holding capacitor 418. The other of the source and the drain is connected to a reference power source line 419. The switching transistor 416 has the function of determining the timing of applying a reference voltage V_{REF} of the reference power source line 419 to the gate of the driving transistor 414.

[0349] The switching transistor 417 is a sixth switching transistor having a gate connected to the control line 431. One of a source and a drain of the switching transistor 417 is connected to the other terminal of the holding capacitor 418, which is a fifth capacitive element, and the other of the source and the drain is connected to the source of the driving transistor 414. The switching transistor 417 is in the off state in a period in which a signal voltage provided through a signal line is stored, thereby preventing a leak current from the holding capacitor 418 to the source of the driving transistor 414 in the period. Thus, the switching transistor 417 has the function of allowing the holding capacitor 418 to hold a voltage accurately corresponding to a signal voltage. In an initialization period, on the other hand, the switching transistor 417 turns on and thus has the function of setting an initial potential at the source of the driving transistor 414, thereby instantaneously resetting the driving transistor 414 and the organic EL element 413. The switching transistors 415, 416, and 417 are implemented by n-type thin-film transistors (n-type TFTs), for example.

[0350] Here, the initialization period is a period for resetting the gate and source potentials of the driving transistor 414 to their initial potentials before a voltage corresponding to a signal voltage is held in the holding capacitor 418. The initialization period is set immediately before a threshold voltage detection period described with respect to the first to fourth embodiments or is set in place of a threshold voltage detection period.

[0351] The control line 431 is connected to the scanning/control line driving circuit 14 and to the pixels belonging to a pixel row including the pixels 41A and 41B. Thus, the control line 431 has the function of producing a state for bringing the source of the driving transistor 414 and a second electrode of the holding capacitor 418 into or out of conduction.

[0352] The first signal line 451 and the second signal line 452 are connected to the signal line driving circuit 15 and to pixels belonging to pixel rows including the pixels 41A and 41B, respectively, and have the function of providing a standard voltage for resetting driving transistors and a signal voltage that determines luminance.

[0353] Power source lines 110 and 112, which are a positive power source line and a negative power source line, respectively, are also connected to other pixels and to voltage sources, not shown in FIGS. 24A and 24B. The reference power source line 419 is also connected to other pixels and to a voltage source with a potential of V_{REF} .

[0354] Connections of the control lines 431, the scanning lines 433, the first signal lines 451, and the second signal lines 452 among the pixels will be described below.

[0355] FIG. 25 is a circuit diagram illustrating a portion of the display panel of the display device according to the fifth embodiment of the present invention. FIG. 25 illustrates two adjacent driving blocks, control lines, scanning lines, and signal lines. The control lines, the scanning lines, and the signal lines are denoted by a reference numeral followed by (block number, row number in the block) or a reference numeral followed by (block number) in the figure and the following description.

[0356] As described earlier, a driving block is made up of a plurality of pixel rows and two or more driving blocks exist in the display panel 10.

[0357] For example, each of the driving blocks depicted in FIG. 25 is made up of m pixel rows.

[0358] In the k -th driving block illustrated in the upper part of FIG. 25, a control line 431 (k) is connected to the gates of the switching transistors 417 of all the pixels 41A in the driving block in common. On the other hand, scanning lines 433 ($k, 1$) to 433 (k, m) are each individually connected to each pixel row.

[0359] In the ($k+1$)-th driving block illustrated in the lower part of FIG. 25, connections similar to those in the k -th driving block are made. However, the control line 431 ($k+1$) connected to the ($k+1$)-th driving block differs from the control line 431 (k) connected to the k -th driving block and individual control signals are outputted from the scanning/control line driving circuit 14 to the control lines 431 (k) and 431 ($k+1$).

[0360] In the k -th driving block, a first signal line 451 is connected to one of a source or a drain of a switching transistor 415 of every pixel 41A in the driving block. On the other hand, in the ($k+1$)-th driving block, a second signal line 452 is connected to one of a source and a drain of a switching transistor 415 of every pixel 41B in the driving block.

[0361] Grouping into driving blocks described above reduces the number of control lines 431 that control connection between the sources of the driving transistors 414 and the second electrodes of the holding capacitors 418. Accordingly, the number of outputs of the scanning/control line driving circuit 14 that output driving signals to the control lines is reduced and the circuit size can be reduced.

[0362] A method for controlling the display device according to this embodiment will be described below with reference to FIG. 26. Here, the control method for the display device having the specific circuit configuration illustrated in FIGS. 24A and 24B will be described in detail.

[0363] FIG. 26 is a timing chart of an operation of a display device driving method according to the first embodiment of the present invention. The horizontal axis of the timing chart represents time. Shown in FIG. 26 in rows are, in order from top, waveforms of voltages appearing on scanning lines 433 ($k, 1$), 433 ($k, 2$), and 433 (k, m), the first signal line 451, and the control line 431 (k) in the K -th driving block. Following these are waveforms of voltages appearing on scanning lines 433 ($k+1, 1$), 433 ($k+1, 2$), and 433 ($k+1, m$), the second signal

line 452, and the control line 431 ($k+1$) in the ($k+1$)-th driving block. FIG. 27 is a flowchart of an operation of the display device according to this embodiment of the present invention.

[0364] First, at time t81, the scanning/control line driving circuit 14 simultaneously changes the voltage level of scanning lines 433 ($k, 1$) to 433 (k, m) from LOW to HIGH to turn on the switching transistors 415 of the pixels 41A that belong to the k -th driving block. The changes of the voltage level of the scanning lines 433 ($k, 1$) to 433 (k, m) simultaneously turn on the switching transistors 416 (S71 of FIG. 27). At this point in time, the voltage level of the control line 431 (k) is already HIGH and the switching transistors 417 are in the on state. At time t81, the signal line driving circuit 15 changes the voltage level of the first signal line 451 from a signal voltage to a standard voltage V_{R1} .

[0365] Here, the timing chart of an operation for driving the selector circuit according to this embodiment is the same as the timing chart of the operation described in the first embodiment and shown in FIG. 8.

[0366] That is, in a certain period of time from time t81, the standard voltage is provided from the data driver 150 to the first signal line 451 and is stored (SAMPLE) in the parasitic capacitor of the first signal line 451 as illustrated in FIG. 9A. The first signal line 451 holds the standard voltage as illustrated in FIG. 9B until the signal line 451 is connected to the signal line driving circuit 15 through the selector circuit 16 and provided with a signal voltage. On the other hand, the second signal line 452 is being provided with a signal voltage from the data driver 150 during this period of time.

[0367] As a result, the reference voltage V_{REF} of the reference power source line 419 is applied to the gate of the driving transistor 414 and the first electrode of the holding capacitor 418 and, through the conduction of the switching transistor 417, the standard voltage V_{R1} of the first signal line 451 is applied to the source of the driving transistor 414 and the second electrode of the holding capacitor 418. That is, the gate potential and the source potential of the driving transistor 414 are initialized (reset) by V_{REF} and V_{R1} .

[0368] In order to cause the organic EL elements 413 to stop producing luminescence at time t81, the reference voltage V_{REF} and the standard voltage V_{R1} are preset so as to satisfy relationships expressed by Formulas 16 and 17, respectively.

$$V_{REF} - V_{CAT} < V_{th} + V_t(EL) \quad (\text{Formula 16})$$

$$V_{R1} - V_{CAT} < V_t(EL) \quad (\text{Formula 17})$$

[0369] An exemplary value that satisfy Formulas 16 and 17 is $V_{REF} = V_{CAT} = V_{R1} = 0$ V.

[0370] Here, V_{th} and $V_t(EL)$ are threshold voltages of the driving transistor 414 and the organic EL element 413, respectively, and V_{CAT} is a cathode voltage of the organic EL element 413. Formula 1 given above represents a condition under which no current flows through a current path from the reference power source line 419 to the driving transistor 414 to the organic EL element 413 to the power source line 412 at time t81. On the other hand, Formula 2 represents a condition under which no current flows through a current path from the first signal line 451 to the switching transistor 415 to the switching transistor 417 to the organic EL element 413 to the power source line 412.

[0371] In this way, at time t81, luminescence production by the organic EL elements 413 of the pixels 41A that belong to the k -th driving block is discontinued and the operation for initializing the driving transistors 414 is started.

[0372] Then, at time t82, the scanning/control line driving circuit 14 simultaneously changes the voltage level of the scanning lines 433 ($k, 1$) to 433 (k, m) from HIGH to LOW to turn off the switching transistors 415 of the pixels 41A that belong to the k -th driving block (S72 of FIG. 27). The changes of the voltage level of the scanning lines 433 ($k, 1$) to 433 (k, m) simultaneously turn off the switching transistors 416. This completes the reset operation of the driving transistor 414 which has started at time t81.

[0373] It should be noted that since characteristics of the gate-source voltage and the drain current applied to the driving transistors 414 have hysteresis, the reset period described above needs to be sufficiently long to accurately initialize the gate potential and the source potential. If a threshold correction or storing operation is started before a sufficient initialization time period has elapsed, a previous change in threshold voltage or mobility in each pixel may remain for a long time due to the hysteresis or other effects. Consequently, unevenness in the luminance of an image is not sufficiently minimized and display degradation such as an image lag cannot be reduced. By providing a sufficiently long initialization time period, the gate and source potentials of the driving transistors 414 can also be stabilized and an accurate initialization operation can be accomplished.

[0374] As has been described above, in the period from time t81 to time t82, the operation for initializing the driving transistors 414 is simultaneously performed in the k -th driving block to set stable initialization voltages, V_{REF} and V_{R1} , at the gate and the source of the driving transistor 414 of every pixel 41a in the k -th driving block.

[0375] Then, at time t83, the scanning/control line driving circuit 14 changes the voltage level of the control line 431 (k) from HIGH to LOW to turn off the switching transistors 417 of the pixels 41A that belong to the k -th driving block. As a result, the switching transistors 417 are out of conduction in the signal voltage storing period which starts at time t84, which prevents a leak current from the holding capacitor 418 to the source of the driving transistor 414 to enable a voltage accurately corresponding to a signal voltage to be held in the holding capacitor 418 in the period. Furthermore, since switching transistor 417 avoids limitation on the period introduced by fast storing for preventing leak current, an intended storing period required for storing an accurate signal voltage can be provided.

[0376] Then, in the period from time t84 to time t85, the scanning/control line driving circuit 14 changes the voltage level of the scanning line 433 ($k, 1$) from LOW to HIGH to LOW to turn on the switching transistors 415 of the pixels in the first row (S73 of FIG. 27). The changes of the voltage level of the scanning line 433 ($k, 1$) simultaneously turn on the switching transistors 416. At this point in time, the voltage level of the first signal line 451 has been changed from the standard voltage to the signal voltage V_{data} .

[0377] Specifically, in a certain period of time from time t84, the standard voltage is provided from the data driver 150 to the second signal line 452 and is stored (SAMPLE) in the parasitic capacitance of the second signal line 452 as illustrated in FIG. 9C. The second signal line 452 holds the standard voltage as illustrated in FIG. 9D until the second signal line 452 is subsequently connected to the signal line driving circuit 15 through the selector circuit 16 and provided with a signal voltage. On the other hand, the first signal line 451 is being provided with a signal voltage from the data driver 150 a certain period of time from time t84.

[0378] As a result, the signal voltage V_{data} is applied to the second electrode of the holding capacitor 418 and the reference voltage V_{REF} of the reference power source line 419 is applied to the gate of the driving transistor 414. An exemplary value of V_{data} is in the range of -5 V to 0 V .

[0379] It should be noted that because the switching transistor 417 is out of conduction in the period from t84 to t85 and the potential at the source of the driving transistor 414 remains at V_{R1} which is the potential from the reset period, no luminescence production current flows in a forward direction in the organic EL element 413.

[0380] Accordingly, after both electrodes are accurately reset, a voltage according to the signal voltage V_{data} is held in the holding capacitor 418.

[0381] Then, by time t86, the storing operation in the period from time t84 to time t85 described above is performed on the pixels in the second to m-th rows that belong to the k-th driving block in order of pixel row.

[0382] Then, at time t87, the scanning/control line driving circuit 14 changes the voltage level of the control line 431 (k) from LOW to HIGH to turn on the switching transistors 417 of the pixels 41A that belong to the k-th driving block (S74 of FIG. 27). At this point in time, the voltage level of the scanning lines 433 ($k, 1$) to 433 (k, m) has already simultaneously changed from HIGH to LOW and therefore the switching transistors 415 and 416 are out of conduction. Accordingly, the voltage held in the holding capacitor 418 in the period from time t84 to t86 becomes the gate-source voltage V_{gs} of the driving transistor 414, which can be expressed by Formula 18:

$$V_{gs} = (V_{REF} - V_{data}) \quad (\text{Formula 18})$$

[0383] Here, V_{gs} is in the range of 0 V to 5 V , for example. Accordingly the driving transistors 414 turn on and a drain current flows into the organic EL elements 413 to cause the organic EL elements 413 in the pixels 41A that belong to the k-th driving block to simultaneously produce luminescence according to V_{gs} defined by Formula 18 given above.

[0384] At this point in time, the potential at the source of the driving transistor 414 is higher than the potential V_{CAT} at the cathode of the organic EL element 413 by V_t (EL) and can be expressed by Formula 19:

$$V_s = V_t(\text{EL}) + V_{CAT} \quad (\text{Formula 19})$$

[0385] From V_{gs} defined by Formula 18 and the source potential defined by Formula 19, the potential at the gate of the driving transistor 414 can be expressed by Formula 20:

$$V_G = (V_{REF} - V_{data}) + V_t(\text{EL}) + V_{CAT} \quad (\text{Formula 20})$$

[0386] As has been described above, grouping the pixel rows into driving blocks enable simultaneous initialization of the driving transistors 414 in the same driving block. Grouping the pixel rows into the driving blocks also can communize the control line 431 in the same driving block.

[0387] While the scanning lines 433 ($k, 1$) to 433 (k, m) are individually connected to the scanning/control line driving circuit 14, these scanning lines are driven by a driving pulse at the same timing in the reset period. Therefore, increase of the frequency of the pulse signal outputted from the scanning/control line driving circuit 14 can be minimized and output load on the driving circuit 14 can be reduced accordingly.

[0388] As has been described above, in the pixels 41A and 41B of the display device in the present invention, the switching transistor 416 is attached between the gate of the driving transistor 414 and the reference power source line 419 and the

switching transistor 417 is attached between the source of the driving transistor 414 and the second electrode of the holding capacitor 418. Since this arrangement stabilizes the potentials at the gate and source of the driving transistor 414, the time from completion of initialization to storing of a signal voltage and the time from the storing of the signal voltage to luminescence production can be arbitrarily set for each individual pixel row. This circuit configuration enables grouping into driving blocks, which enables the threshold voltage correction in the same driving block to occur in the same period and luminescence production in the same driving block to occur in the same period.

[0389] Furthermore, by providing the selector circuit 16, the signal voltage and the standard voltage are mutually exclusively provided to the first signal line 451 and the second signal line 452. Therefore, only one output line of the signal line driving circuit 15 needs to be provided for two signal lines disposed in each pixel column. Accordingly, the size of the signal line driving circuit 15 can be reduced. The reduction of the number of data drivers 150 and the number of output lines reduces the cost for mounting of the driving circuit and improves manufacturing yield.

[0390] For the same reason as described in the first embodiment, this embodiment has the advantage that a longer luminescence production duty cycle can be ensured than the conventional display device using two signal lines described in Japanese Unexamined Patent Application Publication No. 2008-122633.

[0391] Accordingly, a long-life display device with a sufficiently high luminance and a lower output load on the driving circuit can be implemented.

[0392] It can be appreciated that when the same luminescence production duty cycle is set for the conventional display device that uses two signal lines and the display device that incorporates block driving according to the present invention, the display device in the present invention can provide a longer threshold detection period.

[0393] Operation of the ($k+1$)-th driving block in the period from time t91 to t97 is the same as that of the k-th driving block and therefore description of the operation will be omitted.

[0394] First, at time t91, the scanning/control line driving circuit 14 simultaneously changes the voltage level of scanning lines 433 ($k+1, 1$) to 433 ($k+1, m$) from LOW to HIGH to turn on the switching transistors 415 of the pixels 41B belonging to the ($k+1$)-th driving block. The changes of the voltage level of the scanning lines 433 ($k+1, 1$) to 433 ($k+1, m$) simultaneously turn on the switching transistors 416 (for example, S21 of FIG. 6). At this time, the voltage level of the control line 431 ($k+1$) is already HIGH and the switching transistors 417 are in the on state. The signal line driving circuit 15 changes the signal voltage of the second signal line 452 from a luminance signal voltage to a standard voltage VR1. As a result, the reference voltage V_{REF} of the reference power source line 419 is applied to the gate of the driving transistor 414 and the first electrode of the holding capacitor 418 and, because the switching transistor 417 is in conduction, the standard voltage VR1 of the second signal line 452 is applied to the source of the driving transistor 414 and the second electrode of the holding capacitor 418. That is, the gate potential and the source potential of the driving transistor 414 are reset by V_{REF} and VR1, respectively.

[0395] In order to cause the organic EL elements 413 to stop producing luminescence at time t91, the reference volt-

age V_{REF} and the standard voltage $VR1$ are preset so as to satisfy the relationships expressed by Formulas 1 and 2, respectively.

[0396] Thus, at time $t91$, the organic EL elements **413** of the pixels **41B** that belong to the $(k+1)$ -th driving block discontinue producing luminescence and the operation of resetting the driving transistors **414** starts.

[0397] Then, at time $t92$, the scanning/control line driving circuit **14** simultaneously changes the voltage level of the scanning lines **433** ($k+1, 1$) to **433** ($k+1, m$) from HIGH to LOW to turn off the switching transistors **415** of the pixels **41B** that belong to the $(k+1)$ -th driving block (for example, **S22** of FIG. 6). The changes of the voltage level of the scanning lines **433** ($k+1, 1$) to **433** ($k+1, m$) simultaneously turn off the switching transistors **416**. This completes the reset operation of the driving transistors **414** which has started at time $t91$.

[0398] It should be noted that since characteristics of the gate-source voltage and the drain current applied to the driving transistors **414** have hysteresis, the reset period described above needs to be sufficiently long to accurately initialize the gate potential and the source potential. If a threshold correction or storing operation is started before a sufficient reset time period has elapsed, variations in threshold voltage and mobility among the pixels are not canceled, the accuracy of storing the luminance signal voltage degrades, and unevenness in the luminance of an image is not sufficiently minimized due to the hysteresis or other effects. Moreover, it takes time to place the gate potential and the source potential of the driving transistors **414** in steady states by initialization voltages to be applied to the gate and the source of the driving transistors. By providing a sufficiently long reset time period, the gate and source potentials of the driving transistors **414** can be stabilized and an accurate reset operation can be accomplished.

[0399] As has been described above, in the period from time $t91$ to time $t92$, the operation of resetting the driving transistors **414** is simultaneously performed in the $(k+1)$ -th driving block and stable reset voltages, V_{REF} and $VR1$, are set at the gate and the source of the driving transistor **414** of every pixel **41B** in the $(k+1)$ -th driving block.

[0400] Then, at time $t93$, the scanning/control line driving circuit **14** changes the voltage level of the control line **431** ($k+1$) from HIGH to LOW to turn off the switching transistors **417** of the pixels **41B** that belong to the $(k+1)$ -th driving block. As a result, the switching transistors **417** are out of conduction in the luminance signal voltage storing period which starts at time $t94$, which prevents a leak current from the holding capacitor **418** to the source of the driving transistor **414** to enable a voltage accurately corresponding to a signal voltage to be held in the holding capacitor **418** in the period. Furthermore, since switching transistor **417** avoids limitation on the period introduced by fast storing for preventing leak current, an intended storing period required for storing an accurate luminance signal voltage can be provided.

[0401] Then, in the period from time $t94$ to time $t95$, the scanning/control line driving circuit **14** changes the voltage level of the scanning line **433** ($k+1, 1$) from LOW to HIGH to LOW to turn on the switching transistors **415** of the pixels in the first row (for example, **S23** of FIG. 6). The changes of the voltage level of the scanning line **433** ($k+1, 1$) simultaneously turn on the switching transistors **416**. At this time, the signal line driving circuit **15** has changed the signal voltage of the second signal line **452** from the standard voltage to the lumi-

nance signal voltage V_{data} . As a result, the luminance signal voltage V_{data} is applied to the second electrode of the holding capacitor **418** and the reference voltage V_{REF} of the reference power source line **419** is applied to the gate of the driving transistor **414**. An exemplary value of V_{data} is in the range of -5 V to 0 V.

[0402] It should be noted that because the switching transistor **417** is out of conduction in the period from $t94$ to $t95$ and the potential at the source of the driving transistor **414** remains at $VR1$, which is the potential from the reset period, no luminescence production current flows in a forward direction in the organic EL element **413**.

[0403] Accordingly, after both electrodes are accurately reset, a voltage according to the luminance signal voltage V_{data} is held in the holding capacitor **418**.

[0404] Then, by time $t96$, the storing operation in the period from time $t94$ to time $t95$ described above is performed on the pixels in the second to m -th rows that belong to the $(k+1)$ -th driving block in order of pixel row.

[0405] Then, at time $t97$, the scanning/control line driving circuit **14** changes the voltage level of the control line **431** ($k+1$) from LOW to HIGH to turn on the switching transistors **417** of the pixels **41B** that belong to the $(k+1)$ -th driving block (for example, **S24** of FIG. 6). At this time, the voltage level of the scanning lines **433** ($k+1, 1$) to **433** ($k+1, m$) has already simultaneously changed from HIGH to LOW and therefore the switching transistors **415** and **416** are out of conduction. Accordingly, the voltage held in the holding capacitor **418** in the storing period from time $t94$ to $t96$ becomes the gate-source voltage V_{gs} of the driving transistor **414**, which can be expressed by Formula 3 given earlier.

[0406] Here, V_{gs} is in the range of 0 V to 5 V, for example. Accordingly the driving transistors **414** turn on and a drain current flows into the organic EL elements **413** to cause the organic EL elements **413** in the pixels **41B** that belong to the $(k+1)$ -th driving block simultaneously producing luminescence according to V_{gs} defined by Formula 3 given earlier.

[0407] As has been described above, grouping the pixel rows into driving blocks enables the simultaneous reset operation of the driving transistors **414** in the same driving block. Grouping the pixel rows into the driving blocks also can communize the control line **431** in the same driving block.

[0408] While the scanning lines **433** ($k+1, 1$) to **433** ($k+1, m$) are individually connected to the scanning/control line driving circuit **14**, these scanning lines are driven by a driving pulse at the same timing in the reset period. Therefore, increase of the frequency of the pulse signal outputted from the scanning/control line driving circuit **14** can be minimized and output load on the driving circuit **14** can be reduced accordingly.

[0409] Thus, after time $t97$, the organic EL elements **413** in the $(k+1)$ -th driving block are simultaneously producing luminescence.

[0410] The operation described above is performed on the $(k+2)$ -th and the subsequent driving blocks in the display panel **10** in sequence.

[0411] Since state transitions of driving blocks producing luminescence by the control method according to this embodiment is the same as in state transition diagram in FIG. **14** and therefore the description of the state transitions will be omitted.

[0412] In this way, in the fifth embodiment, the pixel circuits in each of which the switching transistors **416** and **417** is disposed, the selector circuit **16** disposed between the signal

line driving circuit **15** and the signal line group **12**, the disposition of the control lines, the scanning lines, and the signal lines in the pixels grouped into driving blocks, and the control method described above enable the driving transistors **414** in the same driving block to be corrected in the same period and at the same timing. Moreover, the provision of the selector circuit can reduce the number of outputs from the signal line driving circuit **15**. The reduction of the number of outputs reduces loads on the scanning/control line driving circuit **14** which outputs a signal controlling current paths, and loads on the signal line driving circuit **15** which controls a signal voltage, as well as the costs of the driving circuit, and improves panel manufacturing yield. Furthermore, grouping into driving blocks and the two signal lines disposed for each pixel row enable a larger part of one frame time T_f in which all pixels are refreshed to be allocated to an initialization period for the driving transistors **414**. This is because an initialization period for the $(k+1)$ -th driving block is provided in a period during which a luminance signal is being sampled in the k -th driving block. Thus, the initialization period is divided among the driving blocks, rather than being divided among the pixel rows. Accordingly, even the display area is increased, a long initialization period can be set relative to one frame time without substantially increasing the number of outputs of the scanning/control line driving circuit **14** and without decreasing the luminescence production duty cycle. Consequently, a driving current based on an accurately corrected signal voltage flows into the luminescence elements, thereby improving display quality.

[0413] For example, if the display panel **10** is divided into N driving blocks, the initialization period that is provided for each pixel is T_f/N at the maximum. In contrast, if initialization periods are set at different timings for M different pixel rows ($M \gg N$), the initialization period that is provided for each pixel is T_f/M at the maximum. If two signal lines as those described in Japanese Unexamined Patent Application Publication No. 2008-122633 are disposed for each pixel row, the initialization period provided is $2T_f/M$ at the maximum.

[0414] Furthermore, grouping into driving blocks enables the control line which controls conduction between the source of the driving transistor **414** and the second electrode of the holding capacitor **418** to be communized in the same driving block. Accordingly, the number of control lines from the scanning/control line driving circuit **14** is reduced and therefore load on the driving circuit is reduced.

[0415] For example, in the conventional display device **500** described in Japanese Unexamined Patent Application Publication No. 2008-122633, two control lines (a power supply line and a scanning line) are disposed for each pixel row. If the display device **500** includes M pixel rows, a total of $2M$ control lines are provided.

[0416] In contrast, in the display device **1** according to this embodiment of the present invention, one scanning line per pixel row and one control line per driving block are provided from the scanning/control line driving circuit **14**. Accordingly, if the display device **1** includes M pixel rows, a total of $(M+N)$ control lines (including scanning lines) are provided.

[0417] When the display area is increased and the number of pixel rows increases accordingly, M will be much greater than N . In that case, the number of control lines of the display device **1** according to the present invention can be reduced to about half the number of control lines of the conventional display device **500**.

[0418] Thus, according to the present invention, a display device and a method for controlling the display device can be implemented that are capable of reducing output loads on driving circuits as well as ensuring a sufficient driving transistor reset period and a period that is long enough to accurately correct the threshold voltage of the driving transistors.

[0419] Specifically, the threshold voltages of the driving transistors in a driving block can be corrected in the same correction period and/or the driving transistors in a driving block can be initialized in the same period and timing. Consequently, the frequency of switching from on to off or off to on of a signal level can be reduced and therefore the load on the driving circuit that drives the pixel circuits can be reduced. The grouping into driving blocks and the two signal lines disposed in each pixel column enable a large part of one frame time to be allocated to a threshold voltage correction period and/or initialization period for the driving transistors. Therefore, a highly accurate driving current flows into the luminescence elements and the display quality is improved accordingly.

[0420] Furthermore, since a single data driver output line is provided for two signal lines, the data drivers can be reduced in size. The reduction of the number of the output lines can reduce the cost of the data drivers and improve panel manufacturing yield.

[0421] In addition, a parasitic capacitance of a signal line may be used to provide the standard voltage for threshold detection or other purposes to the pixels, thereby eliminating the need for providing an extra circuit for providing the standard voltage in a periphery of the panel. Accordingly, the width of a frame of the panel can be reduced and the manufacturing yield of the panel can be improved.

[0422] This is implemented by using a sample and hold operation in the parasitic capacitances of the signal lines to set the standard voltage for threshold detection and providing the selector circuit capable of distributing video signals to intended signal lines in a time sequence.

[0423] It should be noted that a standard signal that differs from a luminance signal needs to be outputted at a constant timing in order to implement the sample and hold operation. This can be achieved simply by making settings in the control circuit **20** so as to control the scanning/control line driving circuit **14** so that the output of the standard signal does not cause a lag in operation for storing an intended luminance signal in intended pixels. However, the constant timing can be ensured by other methods as well, of course.

[0424] For example, as illustrated in FIG. **28A**, dummy terminals **553**, which are unconnected terminals, may be provided in a scanning/control line driving circuit **54**. FIG. **28A** is a block diagram illustrating an exemplary electrical configuration of a display device according to the present invention. With this configuration, a period in which a dummy terminal **553** of the scanning/control line driving circuit **14** in an intended driving block is selected can be used as a standard voltage sampling period, so that a required driving timing can be provided. This configuration has an advantageous effect of eliminating the need for making an extra setting for providing a sampling period.

[0425] Alternatively, as illustrated in FIGS. **28B** and **28C**, a configuration may be used in which a clock signal inputted into the scanning/control line driving circuit **14** is changed. FIG. **28B** is a diagram illustrating an example of a clock signal inputted into the scanning/control line driving circuit **14** and FIG. **28C** is a diagram illustrating an exemplary con-

figuration of a clock circuit for inputting the clock signal into the scanning/control line driving circuit 14. Specifically, a base clock signal (CLK) and an enable signal (ENM) are inputted into an AND circuit. When the enable signal is HIGH, the clock signal is inputted in the scanning/control line driving circuit 14. With this configuration, transfer on scanning lines in synchronization with CLK can be controlled by forcing the enable signal LOW only in standard voltage sampling periods, thereby preventing output of a standard signal from causing a lag in operation of storing an intended luminance signal in intended pixels.

[0426] FIG. 29 is a block diagram illustrating another exemplary electrical configuration of a display device according to the present invention. While it has been assumed in the description of the first to fifth embodiments that the two signal lines, namely the first signal line and second signal line, are disposed adjacent to each other, arrangement of the signal lines is not limited to this. Signal lines that are driven to a standard potential (hold a standard voltage) at the same time instant may be disposed adjacent to each other. That is, first signal lines 651 may be disposed adjacent to each other and second signal lines 652 may be disposed adjacent to each other.

[0427] For example, an odd-numbered column of an odd-numbered driving block is connected to a right second signal line 652 and an even-numbered column of the odd-numbered driving block is connected to a left first signal line 651; An odd-numbered column of an even-numbered driving block is connected to a left first signal line 651 and an even-numbered column of the even-numbered driving block is connected to a right second signal line 652. The adjacent signal lines arranged in this way are always driven to a standard potential (that is, hold a standard voltage) at the same time instant (in the same time period).

[0428] This arrangement has an additional advantageous effect of preventing potential variation noise from another signal line (for a first signal line, noise from a second signal line; for a second signal line, a noise from a first signal line) through a capacitance during a period in which the signal lines hold the standard voltage (a HOLD period).

[0429] FIG. 30A is a diagram for explaining a voltage drop in a HOLD period. FIG. 30B is a diagram for explaining a method for minimizing an influence of a voltage drop. FIG. 30C is a block diagram illustrating another exemplary electrical configuration of a display device according to the present invention. As illustrated in FIG. 30A, leak current can flow through switching transistors 115 of pixels 11B in region X in a period in which a first signal line 151 holds a standard voltage in a parasitic capacitance in region Y (HOLD period), for example. If ESD (Electro Static Discharge) elements indicated in region Z are provided in the display device, leak current can flow through the ESD elements. That is, leak current can cause a voltage effect, which hinders holding of the standard voltage during a HOLD period of the first signal line 151.

[0430] In view of this problem, the number of operations of sampling the standard voltage into the parasitic capacitance of the first signal line 151 may be increased, for example doubled as illustrated in FIG. 30B. Alternatively, the configuration illustrated in FIG. 30C may be provided to prevent leak current through EDS elements. Specifically, ESD elements of signal lines that are driven at the same timing may be connected together as illustrated in FIG. 30C. For example, ESD elements each of which is provided for each of the first signal lines 151 may be connected together through an ESD line 910 and ESD elements each of which is provided for each of the second signal lines 152 may be connected together through an

ESD line 911. This configuration has an advantageous effect of avoiding leak current by driving the ESD line 910 (or the ESD line 920) to the same potential as the standard voltage when the first signal lines 151 (or the second signal lines 152) hold the standard voltage.

[0431] It is noted that display devices according to the present invention are not limited to the embodiments described above. The present invention includes other embodiments implemented by combining any of the components of first and second embodiments, modifications to the first and second embodiments that may occur to those skilled in the art without departing from the spirit of the present invention, and various apparatuses incorporating a display device according to the present invention.

[0432] While selecting transistors in the embodiments described above have been described as n-type transistors which turn on when the gate voltage level is HIGH, grouping into driving blocks described in the embodiments can also be applied to pixels in which the switching transistors are implemented by p-type transistors, and the same effects as those of any of the embodiments described above can be achieved. For example, in the fifth embodiment, the driving transistor 414 and the switching transistors 415, 416, and 417 in the pixel 41A illustrated in FIG. 24A may be implemented by p-type transistors, the power source line 110 may be negative-voltage power source line, the power source line 112 may be positive-voltage power source line, and an organic EL element may be connected between the drain of the driving transistor and the power source line 110, instead of the organic EL element 413, so that the direction from the driving transistor toward the power source line 110 becomes the forward direction. The same applies to the pixel 41B illustrated FIG. 24B. In the operation timing chart in FIG. 26, the polarity of the scanning lines may be reversed. Such a display device has the same effects as that of the fifth embodiment.

[0433] A display device according to the present invention may be incorporated in a thin, flat TV as the one illustrated in FIG. 31. Incorporation of the display device according to the present invention enables implementation of a thin, flat TV capable of displaying high-resolution images reflecting video signals.

[0434] Although only some exemplary embodiments of this invention have been described in detail above, those skilled in the art will readily appreciate that many modifications are possible in the exemplary embodiments without materially departing from the novel teachings and advantages of this invention. Accordingly, all such modifications are intended to be included within the scope of this invention.

INDUSTRIAL APPLICABILITY

[0435] The display device and the method of controlling the same according to the present invention are particularly useful as an active-type organic EL flat panel display which causes luminance to fluctuate by controlling pixel luminescence generation intensity according to a pixel signal current, and as a method of controlling the active-type organic EL flat panel display.

What is claimed is:

1. A display device including pixels arranged in rows and columns, the display device comprising:
 - a signal line driving circuit that selectively outputs, to an output line disposed in each of the columns, a standard voltage and a signal voltage that determines luminance of the pixels;

a first signal line and a second signal line that are disposed in each of the columns, for applying the standard voltage or the signal voltage to the pixels;

a selector disposed in each of the columns, for applying the standard voltage or the signal voltage outputted from the output line selectively to one of the first signal line and the second signal line;

a first power source line and a second power source line; and

a scanning line disposed in each of the rows,

wherein the pixels compose at least two driving blocks each of which includes at least two of the rows,

each of the pixels includes:

a luminescence element that includes terminals, one of the terminals being connected to the second power source line, and the luminescence element producing luminescence according to a flow of a signal current corresponding to the signal voltage; and

a current control unit connected to the first power source line and the other of the terminals of the luminescence element, and configured to convert the signal voltage applied to the current control unit into the signal current, and hold an initializing voltage or a voltage corresponding to a threshold voltage when the standard voltage is applied to the current control unit, the initializing voltage being a voltage for initializing,

each of the pixels in a k-th driving block of the driving blocks further includes a first switching transistor that includes a gate connected to the scanning line, one of a source and a drain connected to the first signal line, and the other of the source and the drain connected to the current control unit, and switchably interconnects the first signal line and the current control unit, k being a positive integer,

each of the pixels in a (k+1)-th driving block of the driving blocks further includes a second switching transistor that includes a gate connected to the scanning line, one of a source and a drain connected to the second signal line, and the other of the source and the drain connected to the current control unit, and switchably interconnects the second signal line and the current control unit,

at least one of a threshold voltage detection period and an initializing period is provided in common for the pixels in a same one of the driving blocks, and at least one of the threshold voltage detection period and the initializing period provided in common in the same one of the driving blocks is provided independently for the pixels in different ones of the driving blocks, the threshold voltage detection period being a period during which the threshold voltage is detected when the standard voltage is applied to the current control unit, and the initializing period being a period during which the current control unit is initialized, and

the display device further comprises

a selector control unit configured to cause the selector to, in one frame period, apply the signal voltage to the pixels in the k-th driving block via the first signal line and subsequently apply the standard voltage to the first signal line, and apply the signal voltage to the pixels in the (k+1)-th driving block via the second signal line and subsequently apply the standard voltage to the second signal line.

2. The display device according to claim 1,

wherein the selector control unit is configured to cause the standard voltage to be held in a parasitic capacitance of each of the first signal line and the second signal line when the selector control unit applies the standard voltage to the first signal line and the second signal line.

3. The display device according to claim 1, further comprising

a first control line disposed in each of the rows, and connected to the current control unit,

wherein the first control line is connected to the pixels in the same one of the driving blocks and not connected to the pixels in the different ones of the driving blocks.

4. The display device according to claim 3, further comprising

a second control line disposed in each of the rows, and connected to the current control unit,

wherein the current control unit includes:

a driving transistor that includes a gate, a source, and a drain, one of the source and the drain being connected to the other of the terminals of the luminescence element, and the driving transistor converting the signal voltage applied between the gate and the source of the driving transistor into the signal current which is a drain current of the driving transistor;

a first capacitive element that includes terminals, one of the terminals being connected to the gate of the driving transistor, and the other of the terminals being connected to the source of the driving transistor;

a second capacitive element that includes terminals, one of the terminals being connected to the source of the driving transistor, and the other of the terminals being connected to the first control line; and

a third switching transistor that includes a gate connected to the second control line, and a source and a drain that are inserted between the first power source line and the other of the terminals of the luminescence element, and switches between ON and OFF states of the drain current of the driving transistor,

the other of the source and the drain of the first switching transistor is connected to the gate of the driving transistor, and

the other of the source and the drain of the second switching transistor is connected to the gate of the driving transistor.

5. The display device according to claim 4,

wherein the second control line is connected to the pixels in the same one of the driving blocks and not connected to the pixels in the different ones of the driving blocks.

6. The display device according to claim 3, further comprising

a second control line disposed in each of the rows,

wherein the current control unit includes:

a driving transistor that includes a gate, a source, and a drain, one of the source and the drain being connected to the other of the terminals of the luminescence element, and the driving transistor converting the signal voltage applied between the gate and the source of the driving transistor into the signal current which is a drain current of the driving transistor;

a third capacitive element that includes terminals, one of the terminals being connected to the gate of the driving transistor, and the other of the terminals being connected to the source of the driving transistor;

- a fourth capacitive element that includes terminals, one of the terminals being connected to the source of the driving transistor, and the other of the terminals being connected to the first control line; and
- a fourth switching transistor that includes a gate connected to the second control line, one of a source and a drain connected to the other of the terminals of the third capacitive element, and the other of the source and drain connected to the source of the driving transistor,
- the other of the source and the drain of the first switching transistor is connected to the gate of the driving transistor, and
- the other of the source and the drain of the second switching transistor is connected to the gate of the driving transistor.
7. The display device according to claim 3, wherein the current control unit includes:
- a driving transistor that includes a gate, a source, and a drain, one of the source and the drain being connected to the first power source line, the other of the source and the drain being connected to the other of the terminals of the luminescence element, and the driving transistor converting the signal voltage applied between the gate and the source of the driving transistor into the signal current;
- a fifth capacitive element that includes terminals, one of the terminals being connected to the gate of the driving transistor;
- a fifth switching transistor that includes a gate connected to the scanning line, one of a source and a drain connected to the one of the terminals of the fifth capacitive element, and the other of the source and drain connected to a reference power source line; and
- a sixth switching transistor that includes a gate connected to the first control line, one of a source and a drain connected to the other of the terminals of the fifth capacitive element, and the other of the source and drain connected to the source of the driving transistor,
- the one of the source and the drain of the first switching transistor is connected to the other of the terminals of the fifth capacitive element, and the other of the source and the drain of the first switching transistor is connected to the first signal line, and
- the one of the source and the drain of the second switching transistor is connected to the other of the terminals of the fifth capacitive element, and the other of the source and the drain of the second switching transistor is connected to the second signal line.
8. The display device according to claim 1, wherein the first power source line is disposed in each of the rows, and applies a first voltage and a second voltage, the first voltage being a voltage lower than the standard voltage, and the second voltage being a voltage higher than the standard voltage,
- the current control unit includes:
- a driving transistor that includes a gate, a source, and a drain, one of the source and the drain being connected to the other of the terminals of the luminescence element, the other of the source and the drain being connected to the first power source line, and the driving transistor converting the signal voltage applied between the gate and the source of the driving transistor into the signal current which is a drain current of the driving transistor;
- a sixth capacitive element that includes terminals, one of the terminals being connected to the gate of the driving transistor, the other of the terminals being connected to the one of the source and the drain of the driving transistor, the sixth capacitive element holding at least a voltage corresponding to the signal voltage or the standard voltage,
- the other of the source and the drain of the first switching transistor is connected to the gate of the driving transistor,
- the other of the source and the drain of the second switching transistor is connected to the gate of the driving transistor,
- the display device further comprising
- a control unit configured to control application of the first voltage and the second voltage in at least one of the threshold voltage detection period and the initializing period with a first timing which is the same for the pixels in the same one of the driving blocks, and control the application of the first voltage and the second voltage with a second timing different from the first timing for the pixels in different ones of the driving blocks.
9. The display device according to claim 1, wherein the luminescence element is an electroluminescence (EL) element that produces the luminescence according to the signal voltage.
10. A method of controlling a display device in which pixels are arranged in rows and columns and compose at least two driving blocks each of which includes at least two of the rows, each of the pixels including a current control unit and a luminescence element, the current control unit including a driving transistor that converts a signal voltage applied via one of a first signal line and a second signal line into a signal current corresponding to the signal voltage, the luminescence element producing luminescence according to a flow of the signal current, the first signal line and the second signal line being disposed in each of the columns, the method comprising:
- holding a voltage corresponding to a threshold voltage or an initialization voltage of the driving transistor simultaneously in the current control unit of each of the pixels in a k-th driving block of the driving blocks by disconnecting the second signal line and a signal driving circuit that selectively outputs the signal voltage or a standard voltage such that the standard voltage is applied by the signal line driving circuit to the first signal line and the standard voltage is held in the first signal line, to thereby apply the standard voltage held in the first signal line simultaneously to the current control unit of each of the pixels in the k-th driving block, k being a positive integer;
- holding a voltage corresponding to the signal voltage, in a pixel row-sequence, in the current control unit of each of the pixels in the k-th driving block by applying the signal voltage from the signal line driving circuit to the first signal line to apply, via the first signal line, the signal voltage from the signal line driving circuit to the current control unit of each of the pixels in the k-th driving

block, after the holding of a voltage corresponding to a threshold voltage or an initialization voltage in the k-th driving block; and
holding the voltage corresponding to the threshold voltage or the initialization voltage of the driving transistor simultaneously in the current control unit of each of the pixels in a (k+1)-th driving block of the driving blocks by disconnecting the first signal line and a signal driving circuit such that the standard voltage is applied by the

signal line driving circuit to the second signal line and the standard voltage is held in the second signal line, to thereby apply the standard voltage held in the second signal line simultaneously to the current control unit of each of the pixels in the (k+1)-th driving block, after the holding of a voltage corresponding to a threshold voltage or an initialization voltage in the k-th driving block.

* * * * *

专利名称(译)	显示装置及其控制方法		
公开(公告)号	US20120200611A1	公开(公告)日	2012-08-09
申请号	US13/443375	申请日	2012-04-10
[标]申请(专利权)人(译)	松井雅文 ONO SHINYA		
申请(专利权)人(译)	松井雅文 ONO, SHINYA		
当前申请(专利权)人(译)	松下电器产业株式会社		
[标]发明人	MATSUI MASAFUMI ONO SHINYA		
发明人	MATSUI, MASAFUMI ONO, SHINYA		
IPC分类号	G09G3/30 G09G5/10		
CPC分类号	H01L27/3276 G09G3/3233 G09G2300/0852 G09G2320/0223 G09G2300/0876 G09G2310/0218 G09G2310/0297 G09G2300/0861		
其他公开文献	US8395567		
外部链接	Espacenet USPTO		

摘要(译)

包括像素的显示装置在其中形成有至少两个驱动块，每个驱动块由像素行组成，并且包括：信号线驱动电路，其将信号电压输出到设置在每个像素列中的输出线；选择器电路，控制设置在每列中的选择器，用于将从输出线输出的信号电压提供给设置在每列中的第一信号线和第二信号线之一，并选择性地提供标准电压或者信号电压从输出线输出到第一信号线或第二信号线之一。每个像素包括电流控制单元和有机EL元件。第k驱动块中的像素连接到第一信号线，第(k+1)驱动块中的像素连接到第二信号线。

